

CONGRATULATIONS ON PURCHASING YOUR X-TERRA!

Metal detecting is a fascinating and rewarding activity enjoyed by people all over the world. By getting to know your X-Terra you can become one of the many who find valuable coins, relics and jewellery on a regular basis.

The X-Terra is a high-precision instrument incorporating Minelab's latest single frequency technology, VFLEX.

VFLEX processes a pure single frequency, ensuring that you can enjoy the hobby at all times, confident that you are using a highly-tuned and dependable detector. In other words, a **SERIOUS** detector.

This pocket sized manual is designed to help both the beginner and expert treasure hunter get the best performance out of the X-Terra 30 or X-Terra 50.



*** This asterisk will appear throughout the manual, indicating features available on the X-Terra 50 model only.**

VFLEX Technology	4	Detecting Basics	
Assembling Your X-Terra	6	Holding the Detector	15
Connecting the Coil	8	Sweeping the Coil	17
Shaft Assembly	9	Introducing the Control Panel	18
Armrest Assembly	10	Keypad Layout	19
Connecting the Control Box	11	Turning on the Detector	20
Coil Cable Assembly	12	LCD Layout	21
Inserting Batteries	13	Detecting Exercise	22
Ready for Use	14	Example Detections	24
Quick Start Reference	Back Cover	How Detectors Work	26
		Target ID	27
		Discrimination Scale	28
		Preset Discrimination Patterns	30
		Choosing a Discrimination Pattern	
		X-Terra 30	32
		X-Terra 50 / All Metal Shortcut	33
		Pinpointing	34
		Recovering the Target	36

Detailed Detector Operation

LCD Icons	38
Operation	42
Selecting Menu Settings	43
Sensitivity	44
Adjusting Sensitivity	45
Volume	46
Adjusting Volume	47
Noise Cancel*	48
Choosing a Noise Cancel Channel*	49
Ground Balance*	50
Adjusting Ground Balance*	52
Editing Discrimination Patterns	
Method 1	54
Method 2	55
Erasing Patterns	56
Factory Presets	57

Reference Information

Sounds	58
Error Messages	60
Battery Behaviour	62
Care of your X-Terra	64
Accessory Headphones	66
Protective Accessories	68
Accessory Coils	69
X-Terra Specifications	70
X-Terra Model Features	71
User Preferences	72



The X-Terra detectors are Minelab's first products to incorporate VFLEX Technology.

VFLEX uses state of the art digital and mixed-signal components to enhance standard single frequency technology by replacing most of the analogue circuitry with digital signal processing. The small amount of analogue circuitry still employed has been very carefully designed and calibrated to obtain the outstanding sensitivity, stability and repeatability required to match the performance of the processing in the digital domain.

This radical departure from traditional approaches to metal detector design has been made possible by advances in electronics that power personal digital assistants, cell (mobile) phones and high-fidelity portable audio.



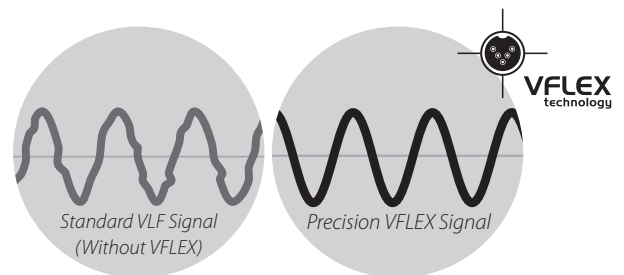

For the X-Terra user, this precision means dependable performance and improved immunity to environmental conditions such as ground mineralization, electromagnetic interference and temperature variations.

VFLEX requires coils that are accurately constructed and calibrated. Every time the detector starts up, the micro-controllers in the control box and the coil establish communication through a digital data link.

Information about the coil is sent to the control box, so the detector 'knows' what type of coil is attached and can set the correct operating parameters.

This optimizes the performance, and also makes the detector 'future proof', in that it will be capable of operating at different frequencies* depending on the electronic properties of the coil.

ASSEMBLING YOUR X-TERRA

Before assembling your X-Terra please check that the package includes these parts:

- ① Coil
- ② Skidplate (fitted to coil)
- ③ Lower shaft
- ④ Middle shaft
- ⑤ Upper shaft
- ⑥ Armrest
- ⑦ Stand
- ⑧ Control box
- ⑨ Rubber washers (2)
- ⑩ Plastic wing nut
- ⑪ Plastic bolt
- ⑫ Armrest screw
- ⑬ Armrest strap
- ⑭ Velcro tabs (2)
- ⑮ Warranty card
- ⑯ Instruction manual
you're holding it 😊

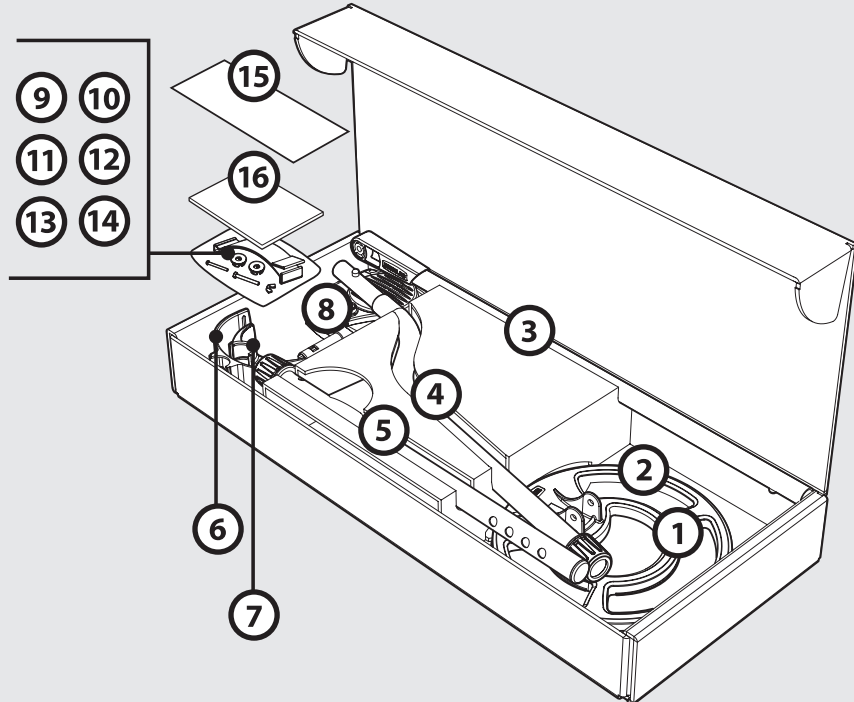

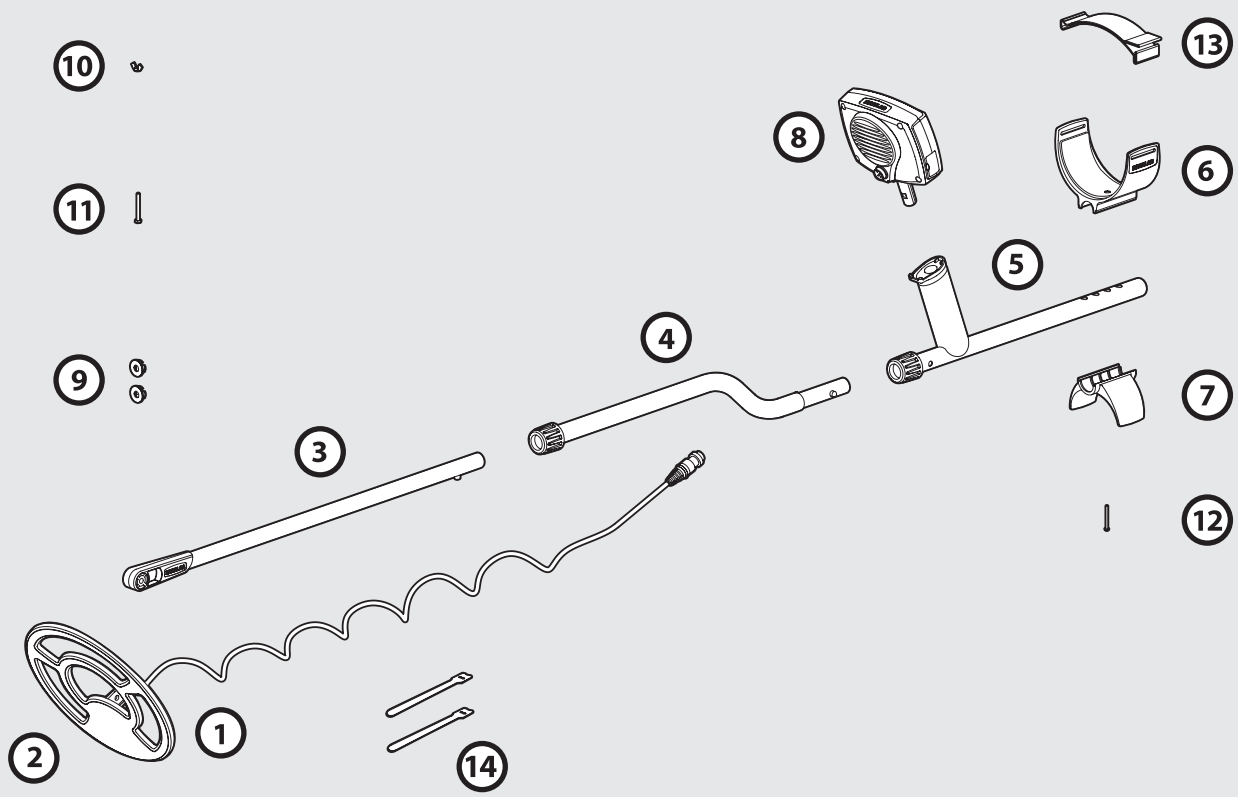

CONNECTING THE COIL

- 1 Plug the two rubber washers into the holes on either side of the lower shaft yoke.
- 2 Slide the yoke into the yoke bracket on top of the coil. Ensure that the spring loaded pin in the lower shaft is underneath.
- 3 Insert the plastic bolt through the yoke and the yoke bracket.
- 4 Fasten with the plastic wing nut provided, being careful not to damage the thread of the bolt by over-tightening. This may need to be loosened to adjust the coil to a comfortable detecting angle.



The coil cable is directly wired into the coil and is not removable. Any attempt to disconnect this cable will void your warranty.

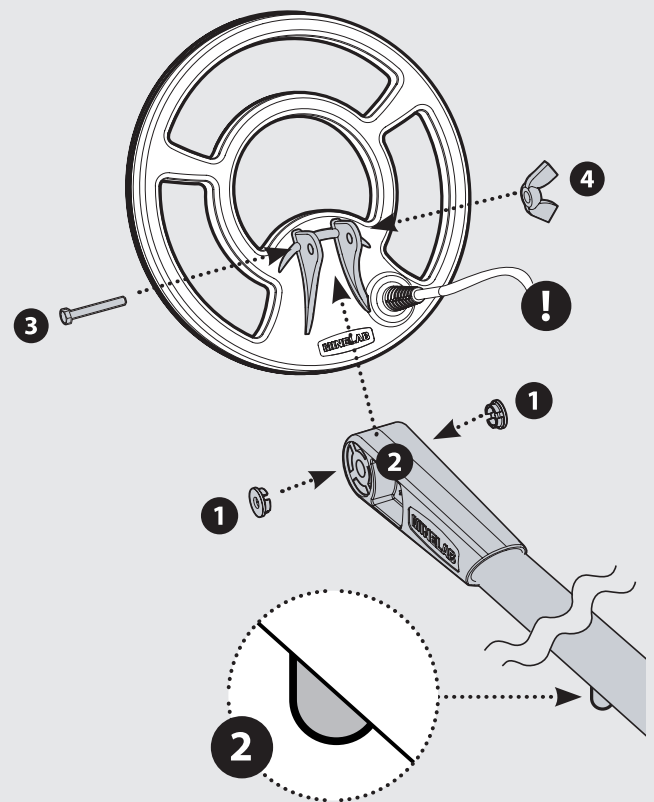

- 1 Ensure that the twistlocks of the shafts are loosened by rotating them counter-clockwise.
- 2 Compress the spring loaded pin in the lower shaft and slide it into the middle shaft until the pin reaches the adjustment holes. The pin will spring out and click into place.
- 3 Attach the middle shaft to the upper shaft in the same way.
- 4 Once shafts are assembled, lock them in position by rotating twistlocks clockwise.



The upper shaft assembly location uses **two** spring loaded pins to strengthen the joint, one on either side of the shaft

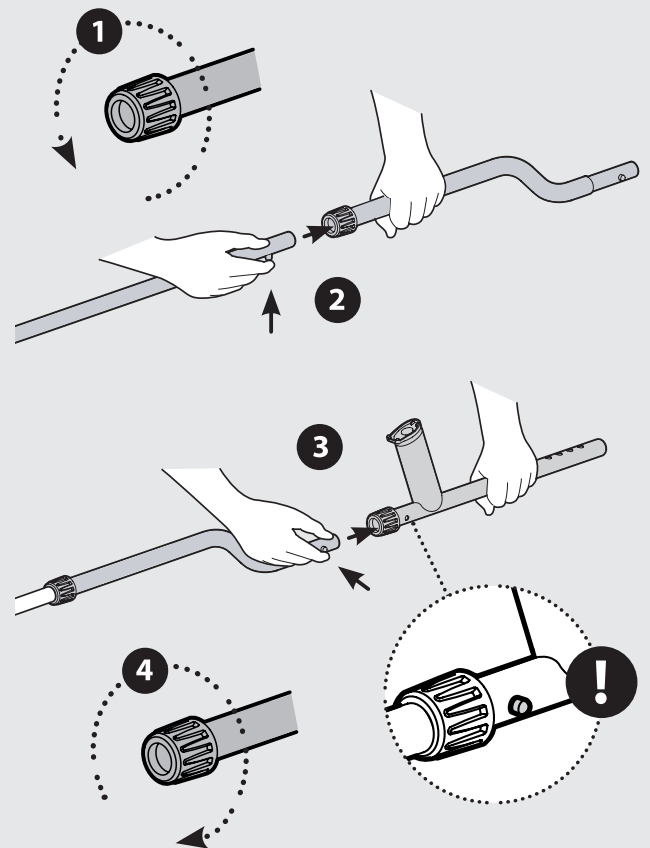

10 ARMREST ASSEMBLY

- 1** Place the armrest onto the top of the upper shaft, lining up the central hole in the armrest with a hole in the aluminium shaft. Position the armrest to suit your arm length.
(Holding the Detector, pg. 15)
- 2** Insert the screw up through the stand, upper shaft and armrest. Tighten the screw, being careful not to overtighten and damage the thread.
- 3** With the velcro side facing upwards, thread the armrest strap through both slots in the armrest. Ensure the end of the strap will be fastened outwards from your arm.



The X-Terra is designed to be used in both the left and right hand. This diagram shows the velcro strap threaded outwards for the left arm.

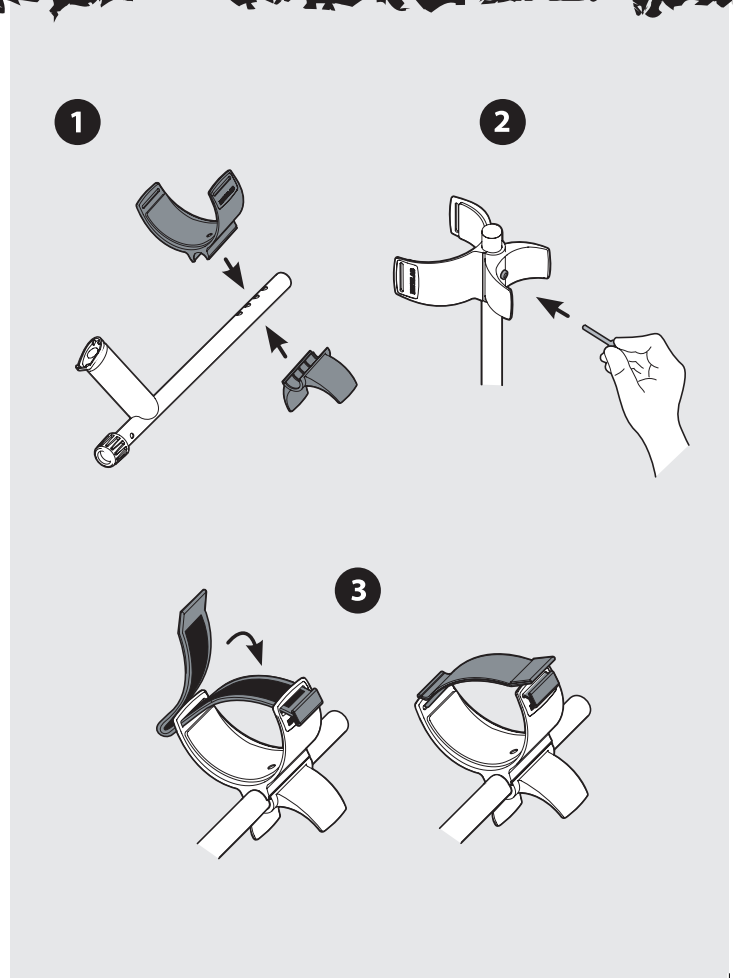

1 Connecting

With the LCD facing up, push the control box onto the end of the handle until it fits into place.



The LCD window has a protective film affixed to prevent scratching. This may be removed when the detector is fully assembled.

The control box may be easily removed for packing and transport in a carry bag.

1 Disconnecting

Brace the detector firmly against yourself, grasp the control box and pull it away from the handle.

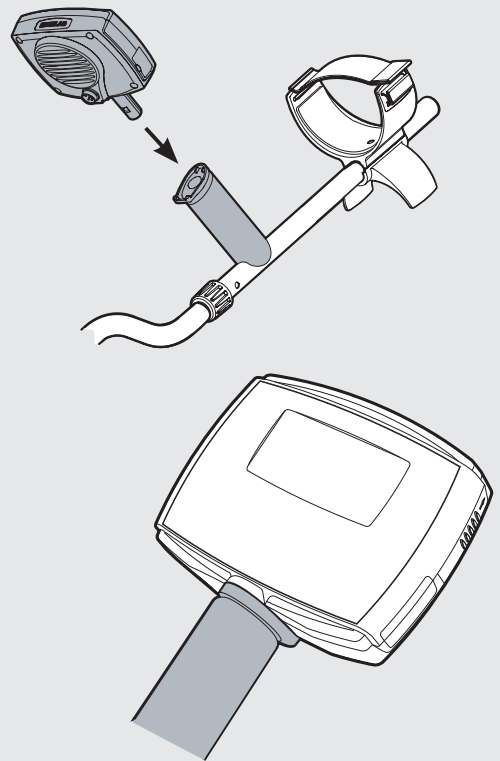

12 COIL CABLE ASSEMBLY

- 1** Wind the coil cable around the lower and middle shaft enough times to take up the slack.
- 2** Use the velcro tabs to keep the coil cable in place against the shaft. It is recommended that one tab is used on the lower shaft close to the coil and the other tab on the middle shaft before the cable reaches across to the control box.
- 3** Align the coil plug and connect into the socket in the back of the control box, lightly tightening the retaining ring to hold it in place.

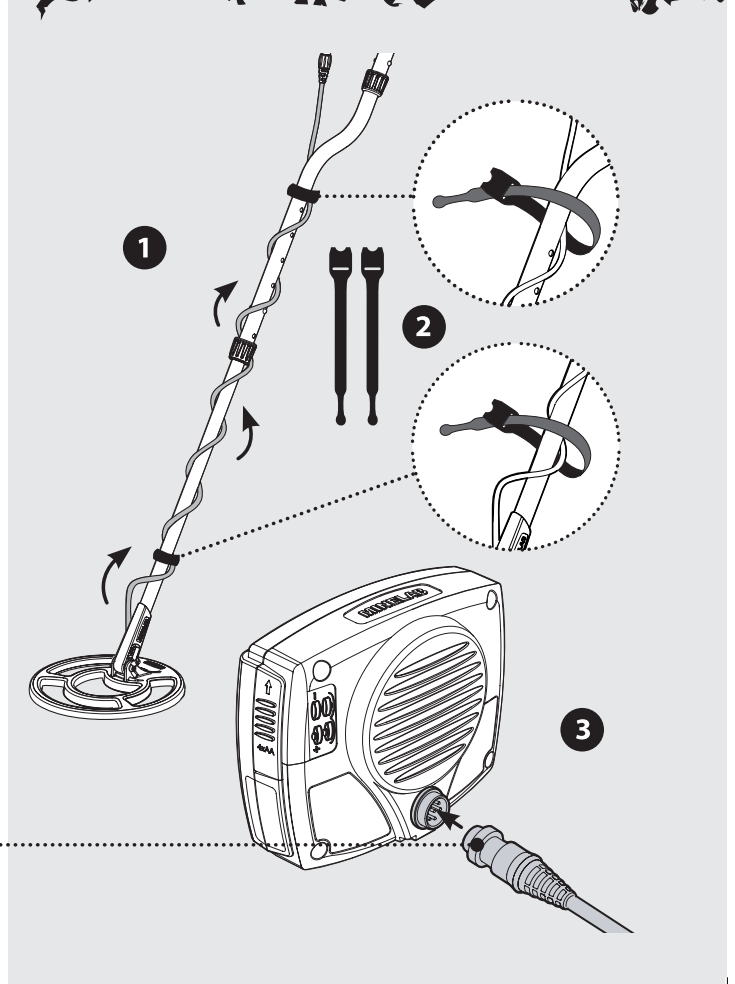

INSERTING BATTERIES 13

The X-Terra uses 4 x AA batteries which are not included with the detector. (*Battery Behaviour, pg. 62*)

- 1** Access the battery compartment via the battery door located on the side of the control box. Slide the battery compartment door upwards with your thumb.
- 2** Place individual batteries into the compartment as illustrated, ensuring the positive (+) and negative (-) contacts match the diagram on the control box.
- 3** Close the battery door by pushing and sliding it downwards.



If the detector does not turn on check the battery orientation. The detector will not be damaged if the batteries are inserted incorrectly.

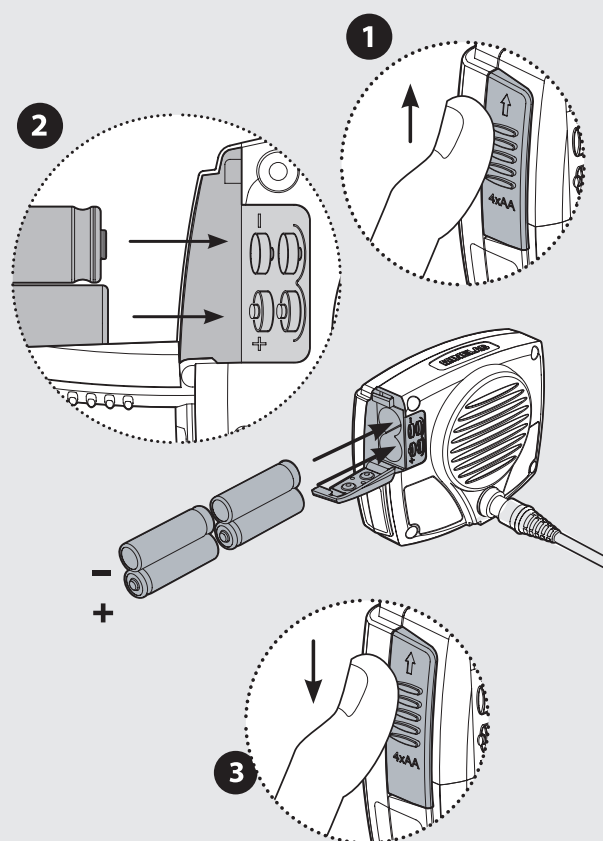

14 **READY FOR USE**

**CONGRATULATIONS!
YOU HAVE SUCCESSFULLY
ASSEMBLED YOUR X-TERRA.
IT IS NOW READY FOR DETECTING!**



HOLDING THE DETECTOR 15



Thread your arm through the armrest and strap. Grasp the handle of the detector and rest your forearm in the armrest.

Your elbow should sit just above the top of the armrest. Lightly tighten the velcro strap and secure it around your arm.

16 HOLDING THE DETECTOR

The correct position of armrest and length of shaft should allow you to swing the coil in front of your body without any uncomfortable stretching or stooping.

To adjust the length of the shafts, undo the twistlocks, compress the spring pins of the shafts and move them up or down to suit. Once all shafts are clipped into position, rotate twistlocks clockwise onto the shafts until a firm clamping action is achieved.

(Shaft Assembly, pg. 9)

To adjust the position of the armrest remove the armrest screw and move the armrest and stand to the desired position.

(Armrest Assembly, pg.10)



Think of the detector as an extension of your arm. It should be straight with your forearm and feel light and comfortable when you pick it up.

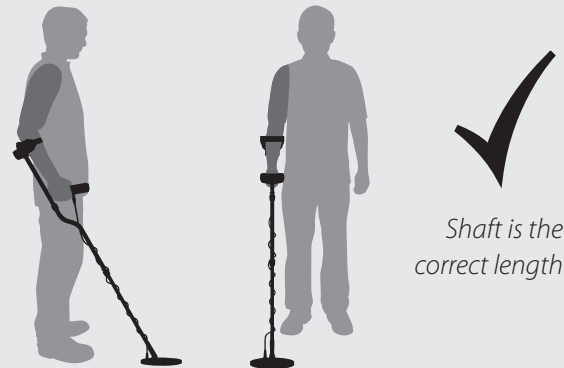

Once outside, practice sweeping the coil over the ground in a side-to-side motion, while walking forward slowly. Slightly overlap the previous sweep to ensure a full ground coverage. An approximate sweep speed is 3 seconds from left to right to left.

It is important to keep the coil close and parallel to the ground at all times. This will increase detection depth and response to small objects. Avoid excessive brushing of the coil on the ground, as this may result in false signals and inaccurate target ID's.

A variation in coil height at the end of each swing may also cause confusing sounds and reduce detection depth.

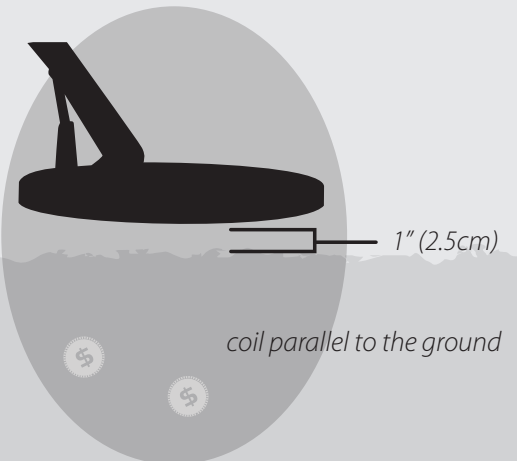
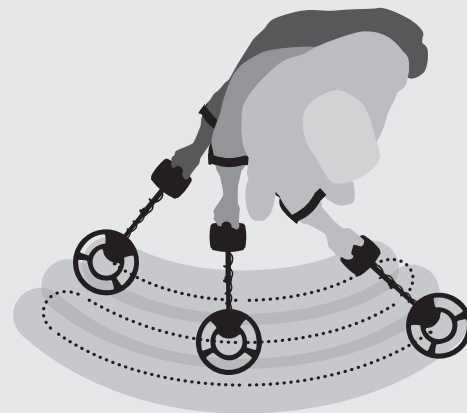

18 INTRODUCING THE CONTROL PANEL



POWER turns the detector on/off.



Accesses and scrolls through detecting settings.



This button has two functions.

Assists in locating the exact position of a target prior to recovery (**PINPOINT**).

Exits menu settings, and returns to detection (**DETECT**).

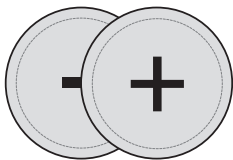

Adjusts settings and scrolls to the left (–) or right (+) through the discrimination segments.



Scrolls through the different discrimination patterns.



Accepts or rejects certain metals by turning on/off individual discrimination segments.



^{*} Toggles between the selected discrimination pattern and the all metal pattern.



^{*} Activates the manual adjustment to compensate for different types of soil.

Liquid Crystal Display (LCD) area

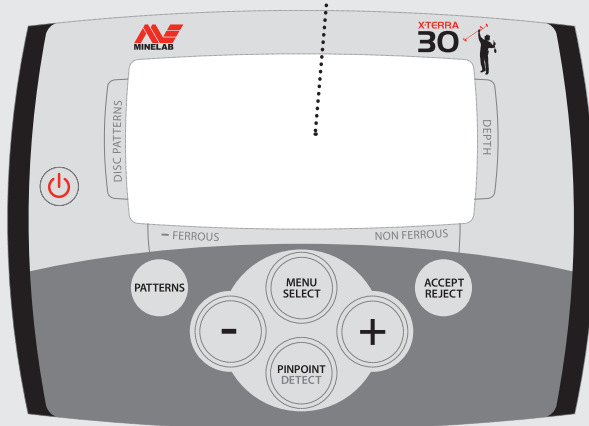

X-TERRA 30



X-TERRA 50

20 TURNING ON THE DETECTOR

There are many metallic objects inside the house (e.g. nails in the floor, reinforcing in the walls) that will result in overloading the detector's electronics. There may also be interference from TV sets and other household appliances. In this environment the detector may give erratic performance and numerous false signals.

If the detector emits an overload sound and displays **OL** (*Error Messages, pg. 61*) move the coil away from the source of the overload.

It is best to only turn the detector on when outside, away from sources of electromagnetic disturbance.

1 Press **POWER**

A short start up sequence will display and a tune will be heard.

Once on, the detector will be in automatic detection. There will be no numeric reading until a metal object is detected.



Overloading is not harmful to the detectors electronics.



Many of the screen pictures in this manual that refer to both models, show the X-Terra 50 display only.

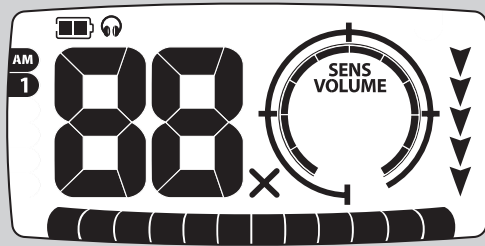
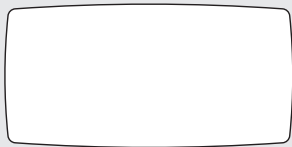

X-TERRA 30

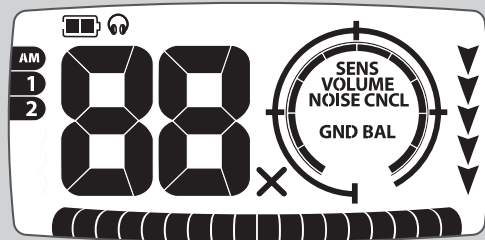

X-TERRA 50



*Blank detection display.
There will be no numerical
reading until a detection
is made.*



This LCD layout is a representation to show the differences between the two models. LCD icons are never all shown at the same time.

22 DETECTING EXERCISE

A good way to become familiar with detecting is to test the detector against a range of metal objects. This exercise is a simple lesson on how the detector interprets metal objects.

Gather a collection of different metal objects, e.g. various coins, gold and silver jewellery, a rusted nail, pull-tab, brass button and aluminium foil.

Take the detector outside, away from known electromagnetic fields or metal objects.

Lay objects in a line, sufficiently spaced apart to allow the coil to pass between the objects.



This test exercise can be used when adjusting the detector's settings (Sensitivity, pg. 44, Volume, pg. 46, Noise Cancel, pg. 48, Ground Balance*, pg. 50)*

Pass the coil across the objects, one at a time, and observe the LCD and the detector's sounds as it detects each object.

Note: If you are getting signals from a clear patch of ground, there may be unknown buried metal objects.

Before attempting to pinpoint or recover real targets it is important to understand how to interpret the audio and visual responses correctly.

If the detector is making popping and crackling sounds and displaying numbers when the coil is not over one of the metal objects, try reducing the detector's sensitivity (pg. 44). Once stable, the detector will only sound and display numbers when the coil is passed over a target.



Don't worry if the detector isn't producing a sound over the nail, this is because the detector begins in the default pattern **1**, a setting which rejects signals from common junk targets.



The X-Terra 50 has additional ways of stabilising the detector's signals for different environments. (Noise Cancel, pg. 48, Ground Balance*, pg. 50)*



The X-Terra coil is waterproof. (Care of Your X-Terra, pg. 64)



24 EXAMPLE DETECTIONS

Discrimination Pattern

The factory preset pattern 1 rejects ferrous metals and foil, and accepts non-ferrous metals. Patterns can be edited and saved according to detecting preferences.

Audio

A detected non-ferrous target will give a medium - high tone audio response.

Visual

A detected non-ferrous target will give a visual indication within the non-ferrous section of the discrimination scale and a positive target ID.

A detected target ID segment (indicated on the diagram by a grey icon) will flash (if accepted) quickly 3 times to show its position on the discrimination scale - just like a cursor on a computer screen. The segment will continue to flash slowly until another target ID segment is detected.

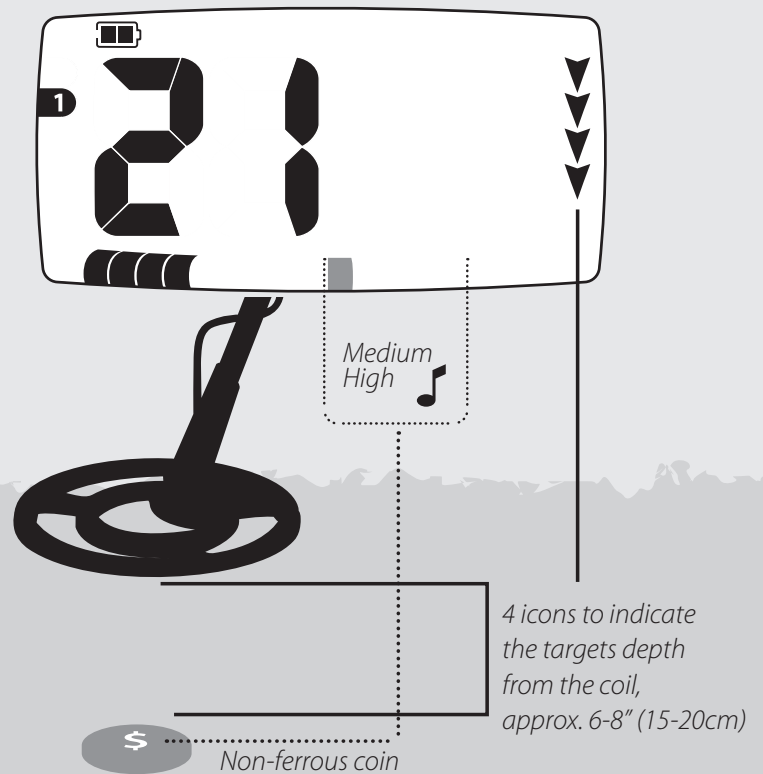

All Metal Pattern

The all metal pattern turns off every discrimination segment, allowing all metals including ferrous targets to be detected.

Audio

A detected ferrous target will give a low tone audio response.

Visual

A detected ferrous target will give a visual indication within the ferrous section of the discrimination scale and a negative target ID.

Further understanding of detector basics and detailed detector operation may be obtained from the rest of this manual.

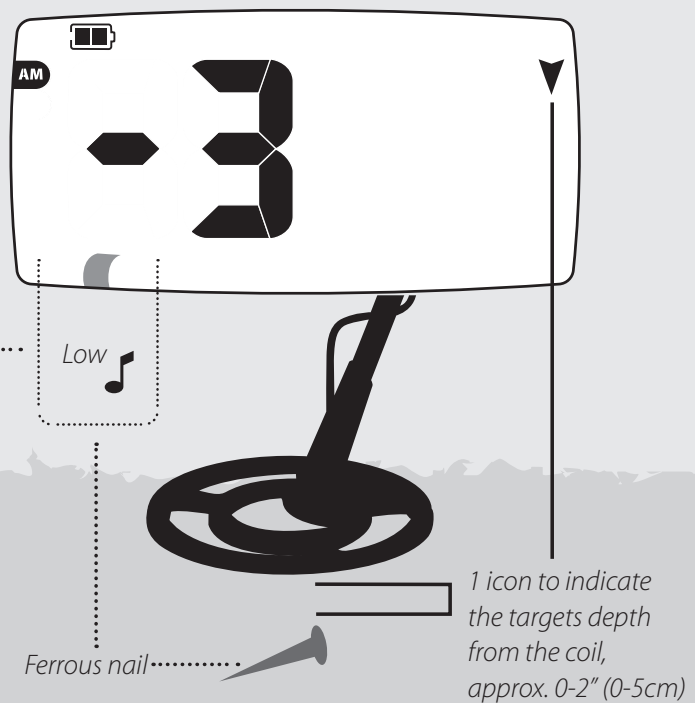

26 HOW DETECTORS WORK

Metal detectors work due to the fact that metal is conductive. Metal detectors create an electromagnetic field, which penetrates the ground.

When the coil senses a change in this field (caused by a metal object) it sends a signal back to the control box which then alerts the operator. Metal detectors react to the size, shape and composition of objects. Typically, the larger the object, the deeper it can be detected.

The X-Terra uses a single frequency (7.5kHz) as the standard operating frequency. This frequency has the ability to penetrate deep into the ground.



The frequency of a detector is the number of times a signal is transmitted into the ground and received back, per second (measured in Hertz - Hz).



The X-Terra has a number of different icons that have been designed to best represent and identify the metal objects in the ground.

Target ID

Buried metal objects are referred to as **targets**. As the coil is passed over a target, it detects its conductivity and displays this as a number. Target Identification (ID) is used to distinguish one type of metal target from another.

Target ID numbers range from -4 to 44 on the X-Terra 30 and -9 to 45 on the X-Terra 50. Negative numbers represent ferrous targets and positive numbers represent non-ferrous targets.

The last detected target ID stays on the display until another target is detected. If the detector passes over a target that it rejects, the display will return to a blank detection screen represented by 2 dashes.

Target ID

The numeric identifier of a particular metal object underneath the ground.

Depth indicator

A guide to how deep a metal object is under the ground. The more arrows displayed, the deeper the object is likely to be from the coil.

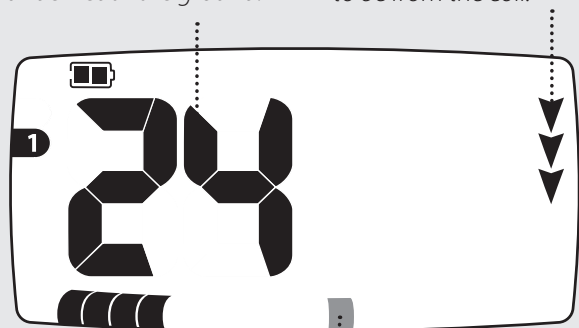

Discrimination segment

Another identifier of metal objects, each segment refers to a certain type of metal signal. Segments can be turned off (to accept targets) or turned on (to reject targets) which in turn accepts or rejects signals from the corresponding metal objects.

(A grey icon on the diagrams in this manual represents a flashing icon on the detector.)

28 DISCRIMINATION SCALE

In addition to the target ID, targets are also represented as a particular segment on a linear scale at the bottom of the display.

Each discrimination segment represents a level of conductivity and ferrous content.

Non ferrous targets are those that have no iron content, such as gold, silver, copper and bronze. Non-ferrous targets are often higher in conductivity and are represented by the right hand side segments.

Ferrous targets are those that contain iron, for example nails and scrap metal. They generally have a low conductivity and are represented by the left hand side segments.

Desired and undesired targets may appear anywhere along the discrimination scale, e.g.

Desired ferrous target - Canadian coin

Undesired ferrous target - iron nail

Desired non-ferrous target - gold coin

Undesired non-ferrous target - pull tab

Discrimination segments can be accepted or rejected, in turn accepting or rejecting certain targets.

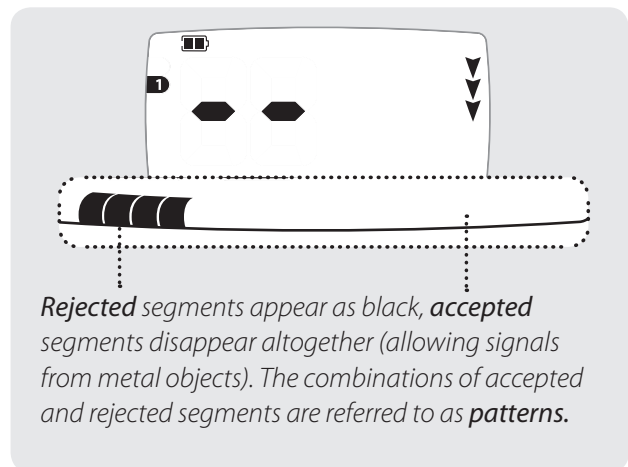

X-TERRA 30

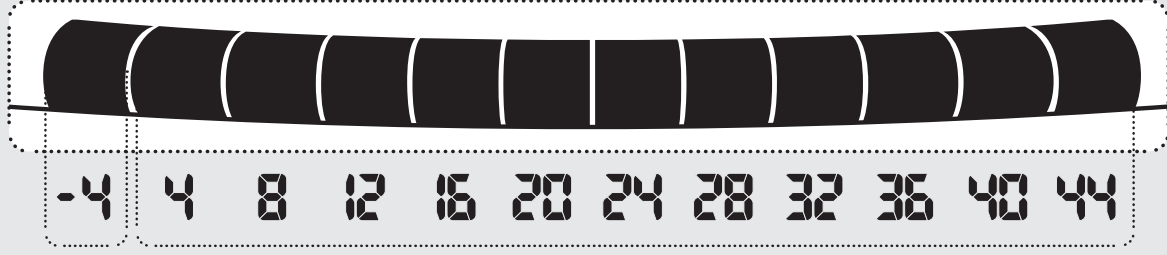

1 ferrous

11 non-ferrous

*The X-Terra 30 has 12 segments.
The target IDs range from -4 up to 44, increasing in steps of 4.*

X-TERRA 50

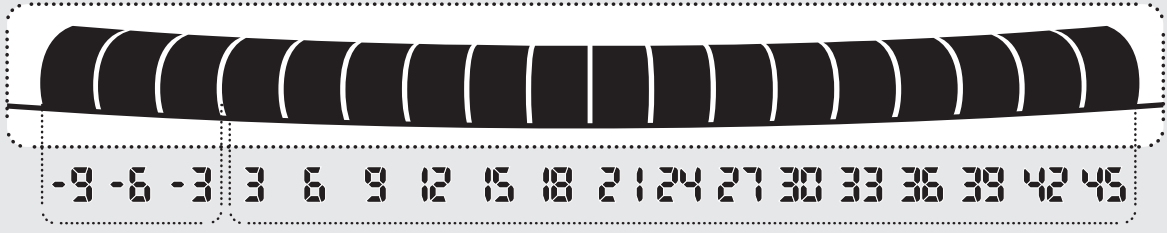

3 ferrous

15 non-ferrous

*The X-Terra 50 has 18 segments.
The target IDs range from -9 to 45, increasing in steps of 3.*

The more segments available, the more separate target IDs available.

30 PRESET DISCRIMINATION PATTERNS

The combinations of accepted and rejected segments are referred to as patterns. The X-Terra has preset discrimination patterns that have been customised to detect general desired targets such as coins and jewellery.

The X-Terra 30 has an all metal pattern and 1 preset pattern. The X-Terra 50 has an all metal pattern and 2 preset patterns.

Patterns 1 and 2 can be edited to create your own custom discrimination patterns. Edited patterns are automatically saved.

(Editing Discrimination Patterns, pg. 54, 55)

(Erasing Patterns, pg. 56)



Patterns are an important part of detecting as they can save you from digging for unwanted targets.

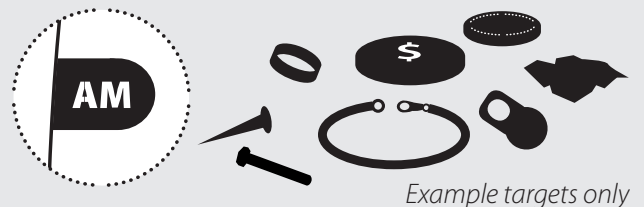

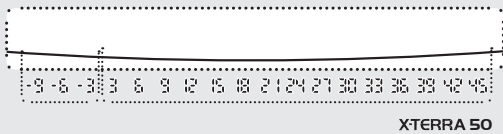
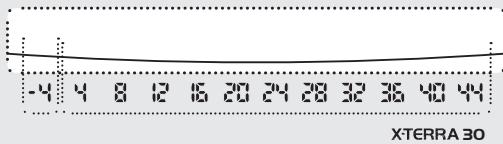

All Metal Pattern

Accepts signals from all types of metals, everything from jewellery to rusty nails (all target IDs).

No target signals are rejected

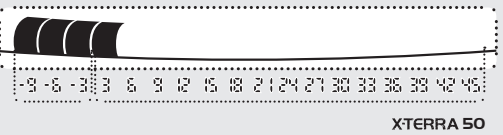
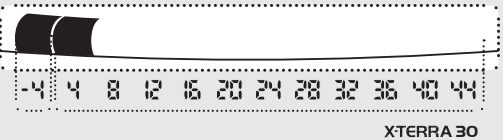

Pattern 1

Accepts signals from non-ferrous targets, e.g. gold and silver coins (X-Terra 30 IDs: 8, 12, 16, 20, 24, 28, 32, 36, 40, 44). (X-Terra 50 IDs: 6, 9, 12, 15, 18, 21, 24, 27, 30, 33, 36, 39, 42, 45).

Rejects ferrous objects and non-ferrous aluminium foil (X-Terra 30 IDs: -4, 4) (X-terra 50 IDs: -9, -6, -3, 3).

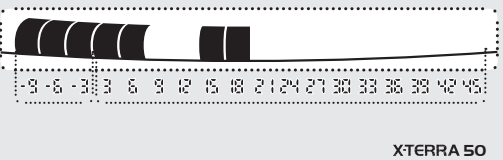

Pattern 2*

Accepts signals from most non-ferrous targets (target IDs 9, 12, 21, 24, 27, 30, 33, 36, 39, 42, 45).

Rejects those from ferrous objects and some non-ferrous targets, e.g. aluminium foil and pull tabs (target IDs -9, -6, -3, 3, 6, 15, 18).

32 CHOOSING A DISCRIMINATION PATTERN - X-TERRA 30

On the X-Terra 30 **PATTERNS** toggles between the all metal pattern (AM) and pattern 1.



The all metal pattern cannot be edited.

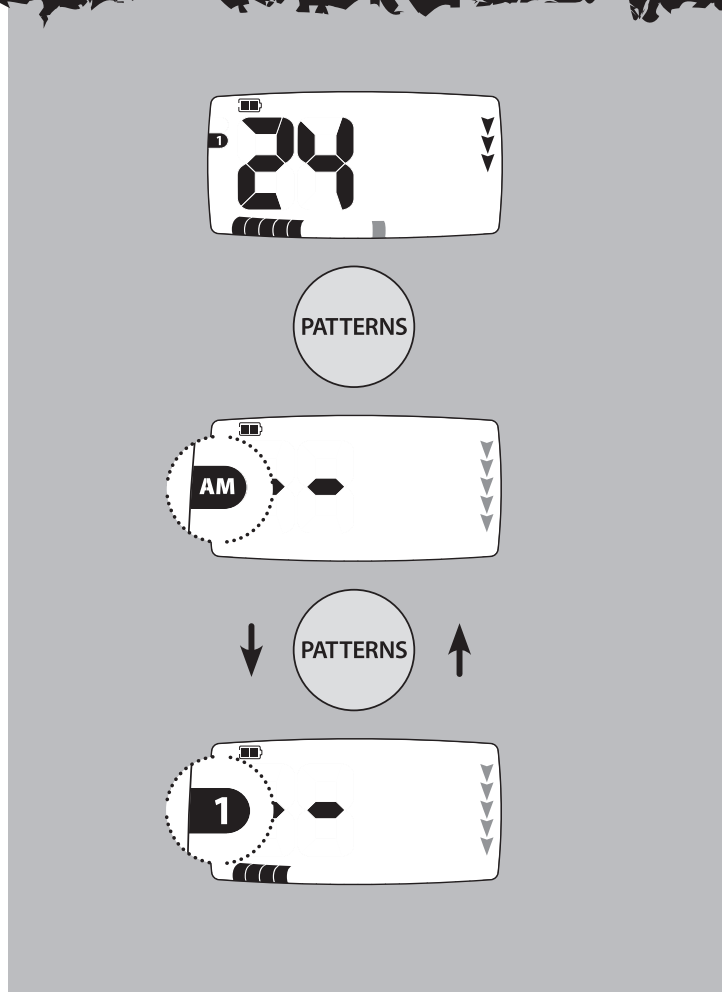

CHOOSING A DISCRIMINATION PATTERN - X-TERRA 50

33

On the X-Terra 50 **PATTERNS** toggles between pattern 1 and pattern 2.

The X-Terra 50 also has an all metal shortcut. This toggles between the selected pattern and all metal.



The all metal pattern cannot be edited.

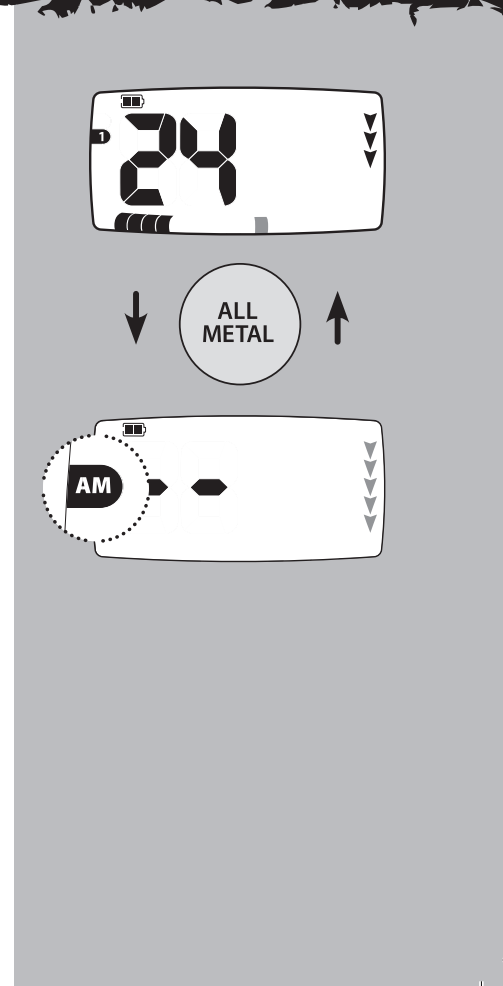
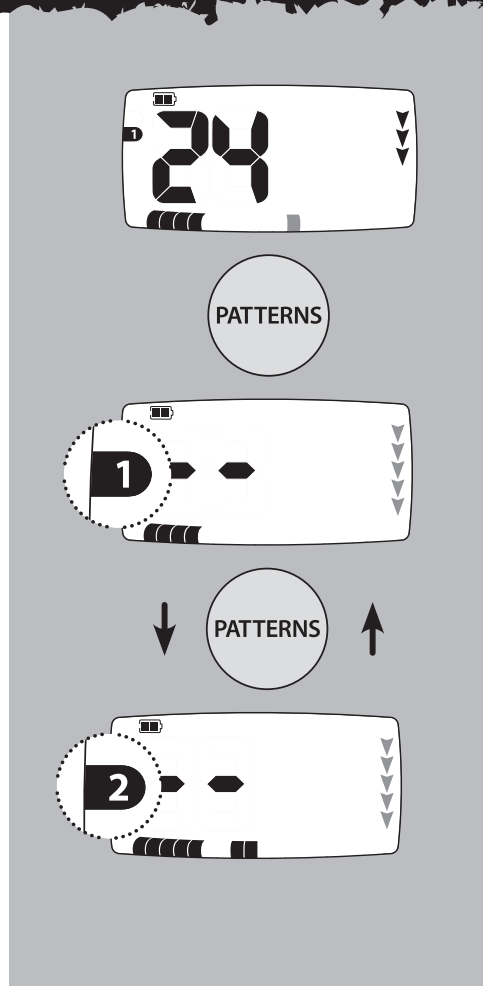

34 PINPOINTING

During normal detection, the X-Terra operates with discrimination patterns. When a target signal is heard, it is an advantage to identify the target's exact position. This is determined by using **PINPOINT**.

Enabling pinpoint instructs the X-Terra to temporarily disengage discrimination and become a non-motion detector. Targets normally discriminated against will emit a signal when beneath the coil.

In pinpoint, the detector gives a continuous audio response as opposed to a single beep while detecting. This continuous response indicates the strength of the target signal directly below the coil.

The pinpoint audio response is tone and volume modulated. The difference in tone and volume produced will help in locating the targets position and depth.

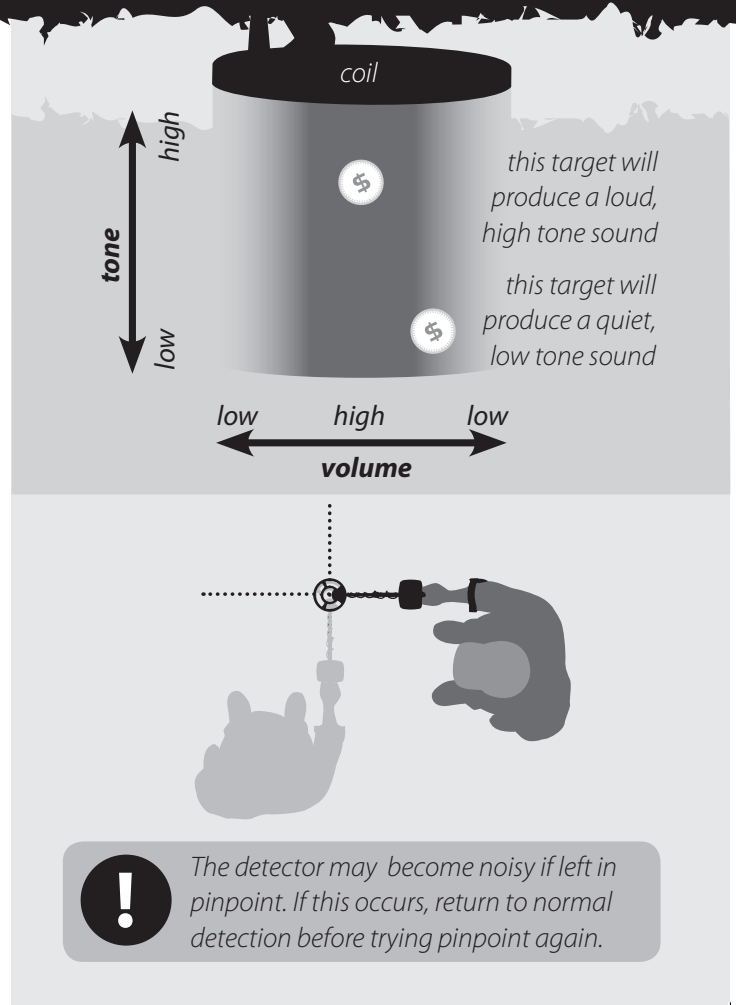

- 1 Once the approximate target location is known, move the coil outside of that area and press **PINPOINT**.
- 2 Sweep the coil over the target location. The menu scale segments on the LCD indicate how close the target is to the center of the coil. The detector will only produce a high volume when the center-ring of the coil is directly above the target.
- 3 Taking note of the detector's response, reduce the span of each successive pass of the coil until you are confident of the target's location. Make a mental note of the position or, if the ground is sandy, mark a line with your shoe or a digging tool.
- 4 Move to one side so that you can pass the coil over the target at a right angle to your initial direction. When the detector sounds you should know exactly where to dig.

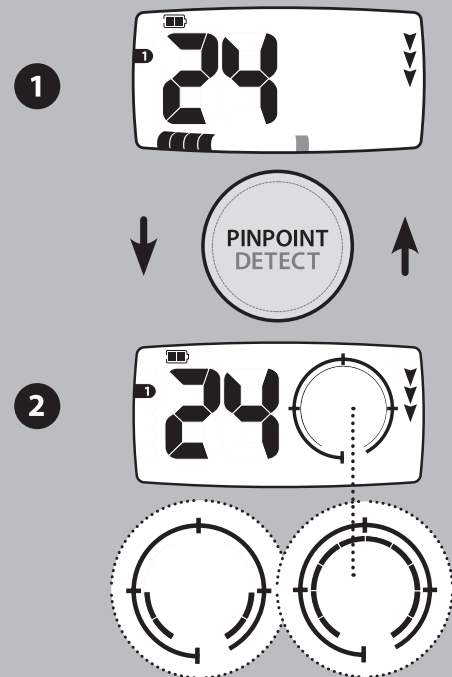

*If you have difficulty pinpointing the target, press **PINPOINT DETECT** again to take the detector out of pinpoint and then return to Step 1.*

36 RECOVERING THE TARGET

A trowel, knife or small spade are good tools for recovering targets.

Once a target has been located, clear the surface of loose material and check again for a signal. If there is no signal then the target is amongst the surface material. In this case, search the surface material until the target is located. If the target is still in the ground, check again with pinpoint.

The aim, when digging, is to leave the area of ground exactly as you found it. Using a sharp tool, cut a neat portion of grass or soil and place it on a plastic sheet. This prevents the material being scattered around and allows the hole to be refilled.



Ask for permission before searching on private property.



A long blunt-tipped screwdriver is a good tool for soft ground. Probe the soil to find the exact location of a target, if it is very shallow, simply prise it out.

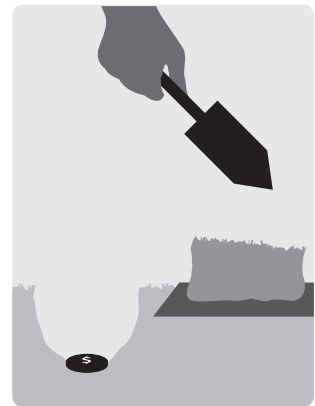
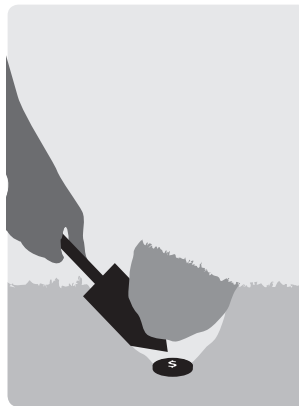

Check the hole for the target. If it is not in the hole, place the detector on the ground with the coil flat, pick up a handful of soil and pass it over the coil. Be sure not to wear rings, bracelets or a watch which will produce a signal. Repeat this procedure until the target is located.

Ensure that no other targets remain, then refill the hole. All soil and portions of grass on the plastic sheet should be returned to the hole as neatly as possible. Step lightly on the soil to compact it.



Leaving holes, or a scarred area may result in action being taken to prevent the use of metal detectors. Please ensure that you leave an area of ground as it was found. Try to take all rubbish.

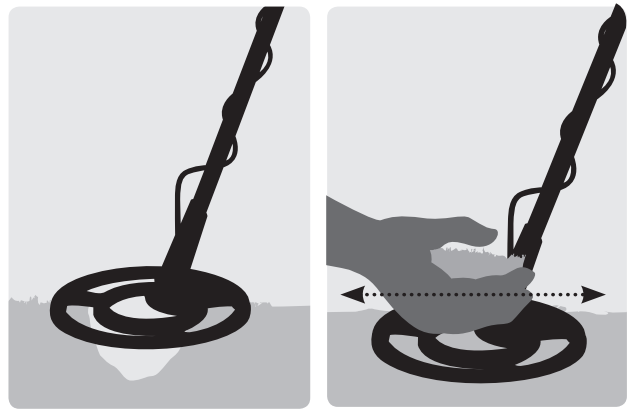

38 LCD ICONS

Target ID

Target signals contain both ferrous and conductivity information. This is digitally processed and results in a number being displayed that distinguishes between different types of metal.

Target ID numbers range from -4 to 44 on the X-Terra 30 and -9 to 45 on the X-Terra 50. Negative numbers represent ferrous targets and positive numbers represent non-ferrous targets.

Numeric ID

These numbers have another function. They are also used when adjusting the menu settings (sensitivity, volume, noise cancel* and ground balance*) showing the numerical value selected.

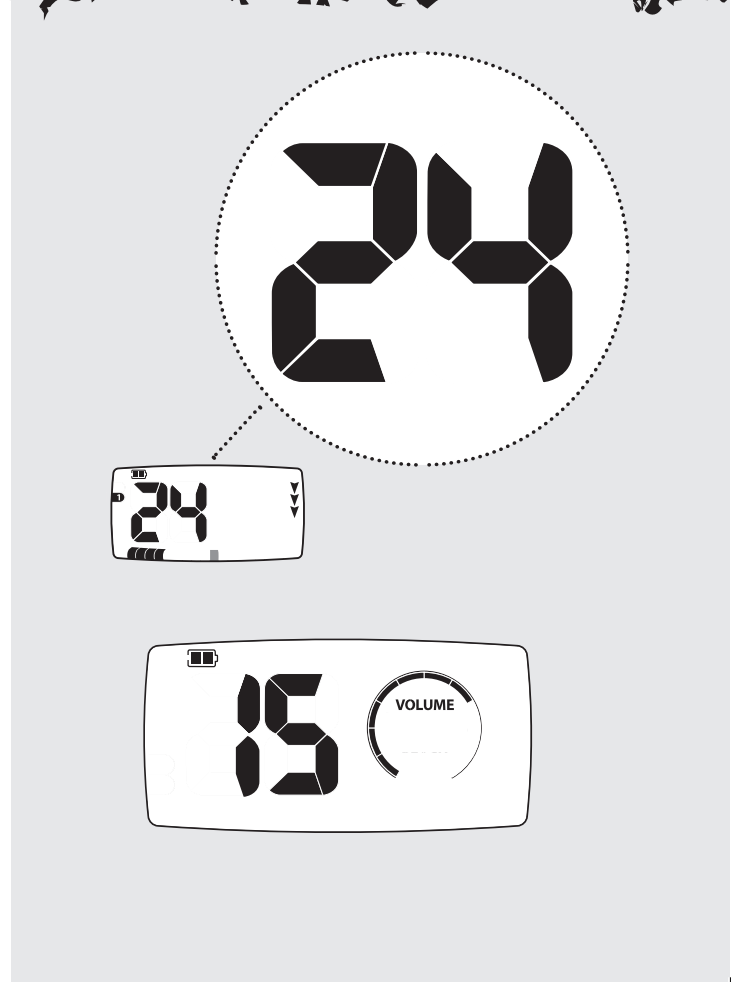

All Metal

AM indicates that the all metal pattern has been selected. This pattern has no discrimination and will allow signals from all types of metals, both ferrous and non-ferrous.

Patterns

Preset discrimination patterns are used to suit different search preferences. X-Terra 30 has 1 pattern, X-Terra 50 has 2 patterns
(*Preset Discrimination Patterns, pg. 30*).

Depth Indicator

The depth indicator is a relative guide to how deep a target is. The more arrows displayed, the deeper the target is likely to be.

1 arrow is approx. 0-2" (0-5 cm)

2 = 2-4" (5-10 cm)

3 = 4-6" (10-15 cm)

4 = 6-8" (15-20 cm)

5 = 8-10" (20-25 cm)



Actual depth will be more accurate for coins than junk ferrous targets

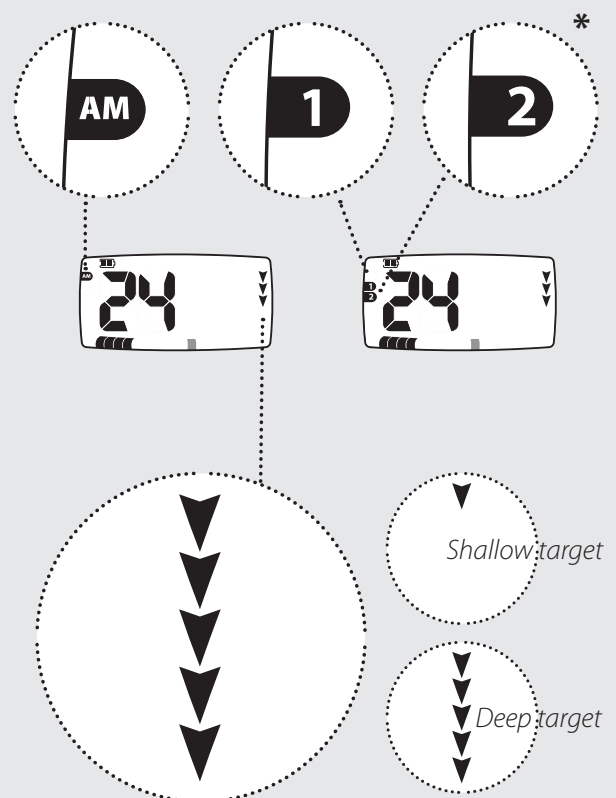

40 LCD ICONS

Menu

The X-Terra has a list of settings (sensitivity, volume, noise cancel* and ground balance*) that can be adjusted to customise it for your own personal preferences. (Note: Ground balance cannot be accessed via the menu key, even though it is in the menu list on the LCD.)

Menu scale

Consists of 10 segments and a circular scale line. This works in conjunction with the numeric ID to show the value of the selected setting adjustment. The menu scale also works with pinpoint to indicate how close the coil is to the target.

Pinpoint

Indicates that pinpoint is activated.



On the X-Terra 50, sensitivity and ground balance* have ranges of 1-20, and volume has a range of 0-20. In these cases each segment of the menu scale represents two numbers.

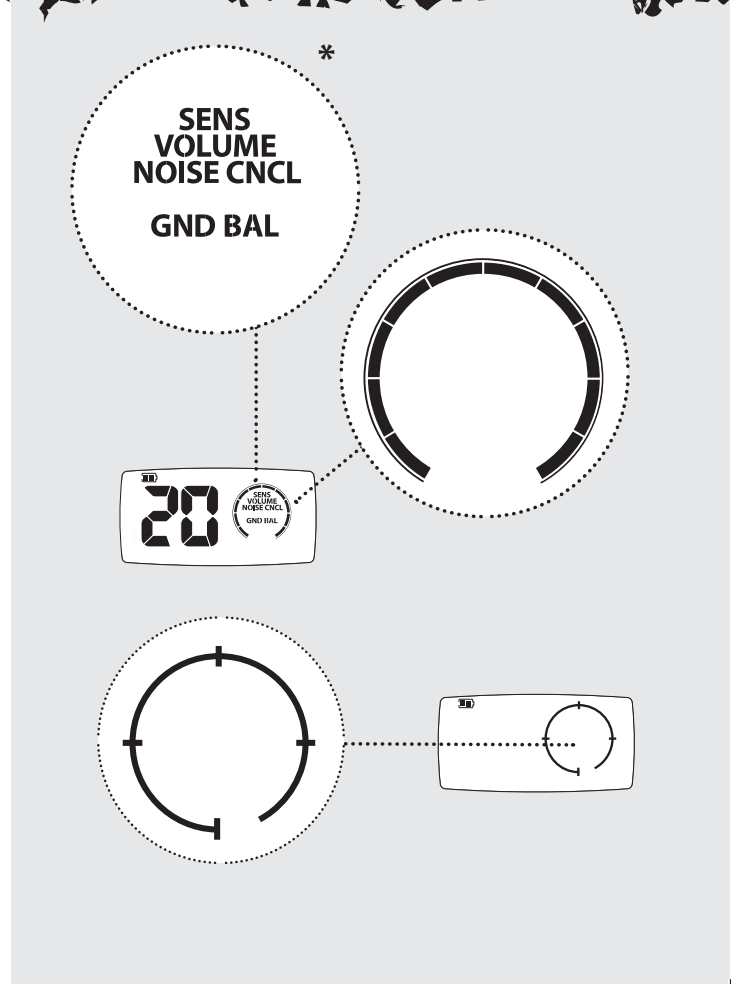

Reject Identification

This icon appears when rejecting a discrimination segment. It disappears when accepting a discrimination segment (pg. 54, 55).

Battery

This icon indicates how much power is left in the batteries (pg. 62).

Headphones:

This icon indicates that the headphones are connected and that the headphone volume has been selected (pg. 66).



Headphones are not included with the X-Terra (Accessory Headphones, pg. 66)

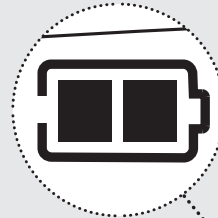

42 OPERATION

The X-Terra operates in two display states – Detection and Settings.

Detection

The target ID, discrimination segments and depth automatically translate detected signals. The last detected target ID stays on the display until another is detected. If the detector passes over a target that it rejects, the display will return to a blank detection screen represented by 2 dashes.

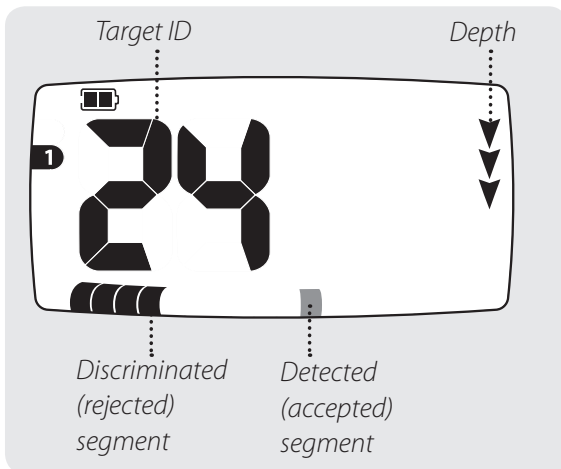

Settings

The X-Terra has a range of settings that should be adjusted to ensure optimum performance in different environments. These settings can be accessed from the menu, or with shortcuts available on the X-Terra 50.

- 1 To access the menu settings, press **MENU SELECT** repeatedly to scroll down through the adjustable settings.
- 2 After exiting settings using **PINPOINT DETECT**, the last detected target ID will disappear and the depth icons will flash in sequence until a new target ID is detected.

Detection

Settings

1



2

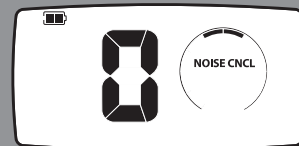
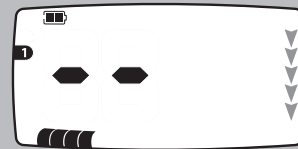

Exits Settings, and returns to a blank detection display

44 SENSITIVITY

The X-Terra detectors are highly sensitive and therefore have a wide sensitivity adjustment range. It is important to set the correct sensitivity level for your detecting conditions.

Sensitivity is the detector's level of response to a target and its environment. Real targets are interpreted as distinct beeps. Interference or false targets are interpreted as crackling or popping noises.

Tiny ferrous junk targets may be detected when the sensitivity is set to a high level. The detector will also be affected by minerals in certain soils and signals from other electric appliances.

X-Terra 30

Sensitivity range = 0-10

Factory preset = 6

X-Terra 50

Sensitivity range = 0-20

Factory preset = 12

Some experimentation with the sensitivity may be required for different areas. For beginners, start with a low setting and increase progressively.

Decreasing the X-Terra's sensitivity may help stabilise the detector, reducing false signals and interference, and assisting in differentiating between signals caused by soil mineralisation and those of metal targets.

Choose the highest stable sensitivity setting to ensure the detectors' optimum performance.

For beach detecting, a setting below 10 may be required. In high trash areas, such as modern parks, a setting below 6 may be required, especially when searching for shallow coins (X-Terra 50 settings).



*The highest sensitivity settings,
(7-10 = X-Terra 30)
(15-20 = X-Terra 50)
should only be used in the quietest,
most stable conditions.*

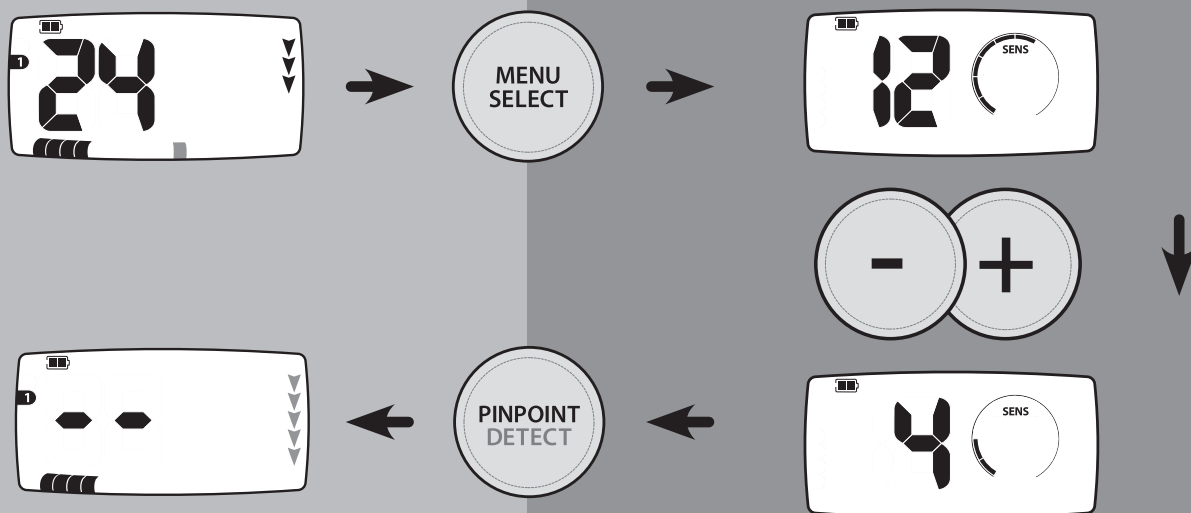

46 VOLUME

Volume is the level of sound the detector gives when a target is detected. The volume control limits the potential loudness of target signals.

The X-Terra has proportional target signal volume. The sound produced by a distant target starts softly. As you get closer, the volume level increases rapidly until it reaches the maximum level that has been set.

The sound produced by the detector in pinpoint or ground balance will vary in volume and tone depending on the signal strength (from a target or ground mineralisation). This volume range is proportional to the maximum volume setting.

X-Terra 30

Volume range = 0-10

Factory preset = 7

X-Terra 50

Volume range = 0-20

Factory preset = 15

The X-Terra is able to save separate settings for both the speaker volume and headphone volume, switching from one to the other as soon as the headphones are connected (*Accessory Headphones, pg. 66*).

Set the speaker volume without headphones connected. Set the headphone volume with the headphones connected. Use the exercise (*pg. 22*) with different targets to confirm both the speaker and headphone volume settings.

When the detector battery is low (indicated by the low battery icon) the speaker volume limit will be reduced. This saves battery power and extends detecting time.

You may choose to override this and increase the volume limit, but you then risk the detector shutting down earlier.

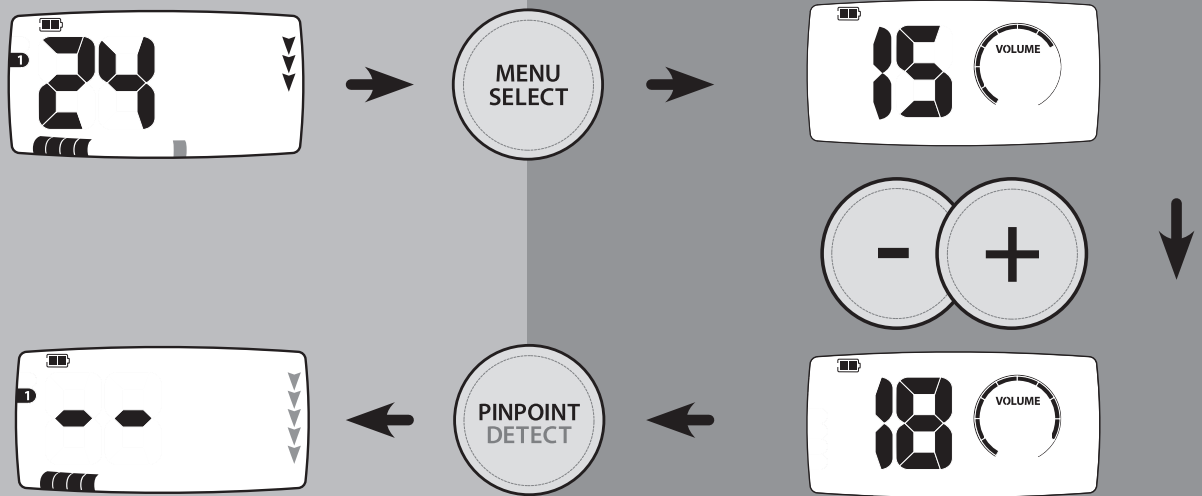

48 NOISE CANCEL*

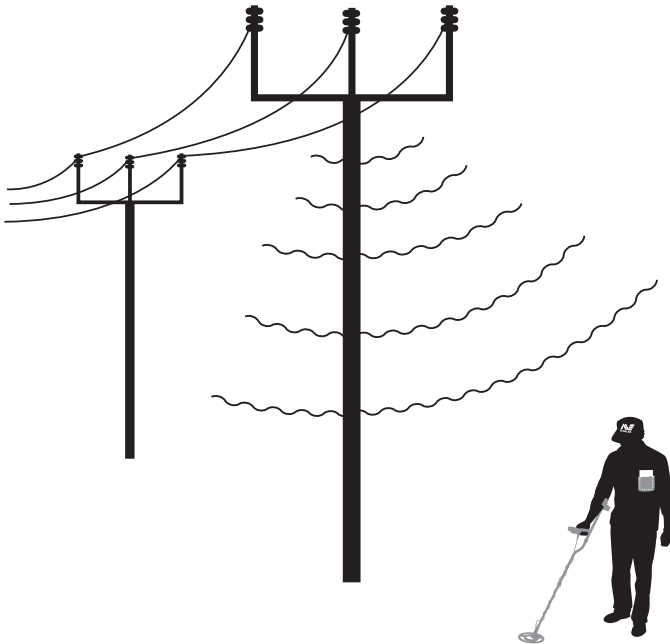

Noise cancel channels = -1, 0, 1
Factory preset noise cancel channel = 0

The detector may become noisy or erratic due to electrical interference from powerlines, electrical equipment or other detectors operating close by. This interference is interpreted as a crackling or popping noise.

Noise Cancel* allows you to change the noise cancel channel so that you experience less interference. Three channels are available, represented by the numbers -1, 0 and 1 and are also indicated on the menu scale.

It is best to choose a channel with the coil in the detection (horizontal) position because interference received in a vertical position may be different from the interference received in the horizontal position.

The coil should be held in the air and away from large targets when changing channels.



There is no loss in depth or sensitivity if the noise cancel channel is changed.

CHOOSING A NOISE CANCEL CHANNEL*

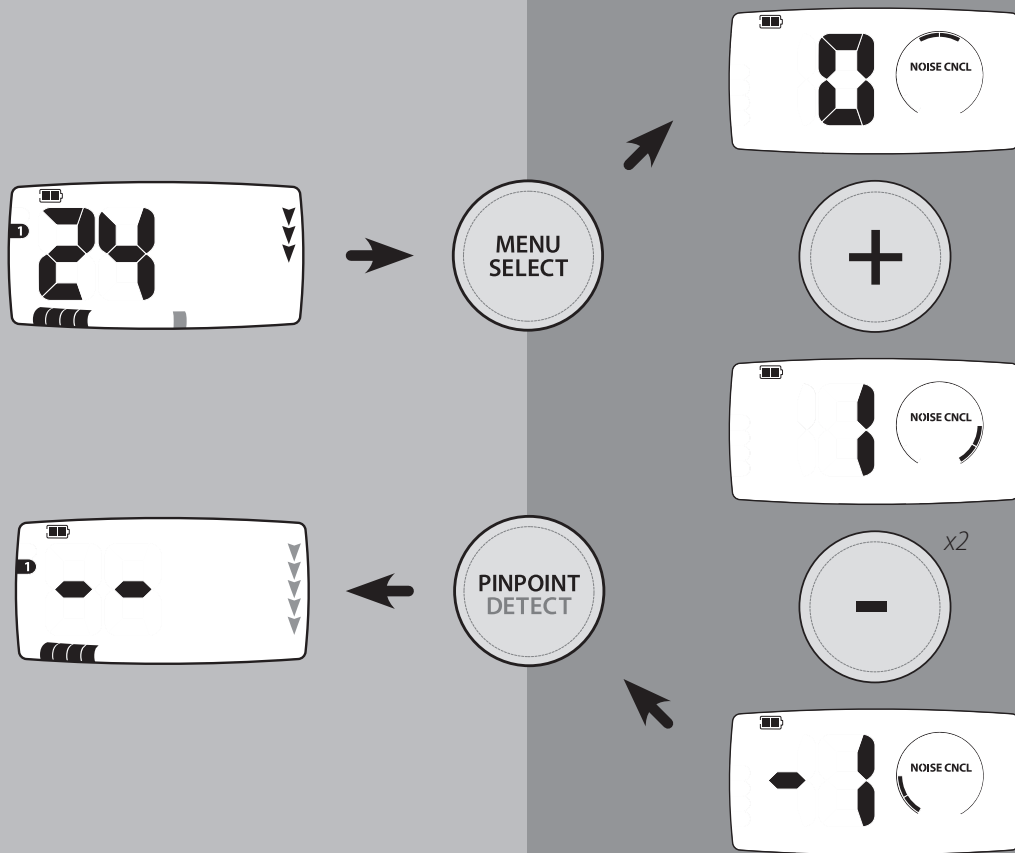

Menu scale segments will flash for 3 seconds while calibrating the channel

The X-Terra 30 has a fixed ground balance that allows adequate operation over most types of soils.

The X-Terra 50 has an adjustable ground balance which helps in compensating for false signals.

When the detector is unbalanced, it will detect targets, but it may also register false detections due to ground mineralisation. These false detections are displayed as -9 in all metal or two dashes when using the factory preset patterns. This will cause good targets to be displayed only briefly and with clipped sound.

*Ground balance range = 0-20
Factory preset = 6*

Ground balancing the detector reduces false detections and enables good targets to be displayed and heard correctly.

Ground balance settings affect both normal discrimination detection and pinpoint operation.

If there is difficulty ground balancing in an area with the X-Terra 50, try reducing sensitivity (pg. 44).



When detecting on the beach, adjusting ground balance may not give significant improvements. Try adjusting sensitivity and altering patterns for best results.

Highly mineralised soil may produce false signals and distract from real targets.



Mineralised ground and 'hot rocks' may register as -9 when detecting in all metal. This is more likely to happen at high sensitivity settings and with an unbalanced detector.

52 ADJUSTING GROUND BALANCE*



If ground balance is in between two numbers, select the lowest number.

- 1 Using the detector in all metal, find a clear area of ground without any targets.
- 2 Hold the coil parallel and 4" (10 cm) above the ground. Select **GROUND BALANCE***. A constant hum known as the ground balance tone will sound when the coil is held steady.
- 3 Continuously lower and raise the coil towards and away from the ground and listen to the ground balance tone. Try to lower the coil as close to the ground as possible without touching it.
- 4 Adjust the ground balance using + and -, listening for minimum volume which will occur during the transition from low to high.

If the tone is low, increase the ground balance setting using +, if the tone is high, decrease the setting using -. The menu scale and numeric ID will indicate the chosen setting.

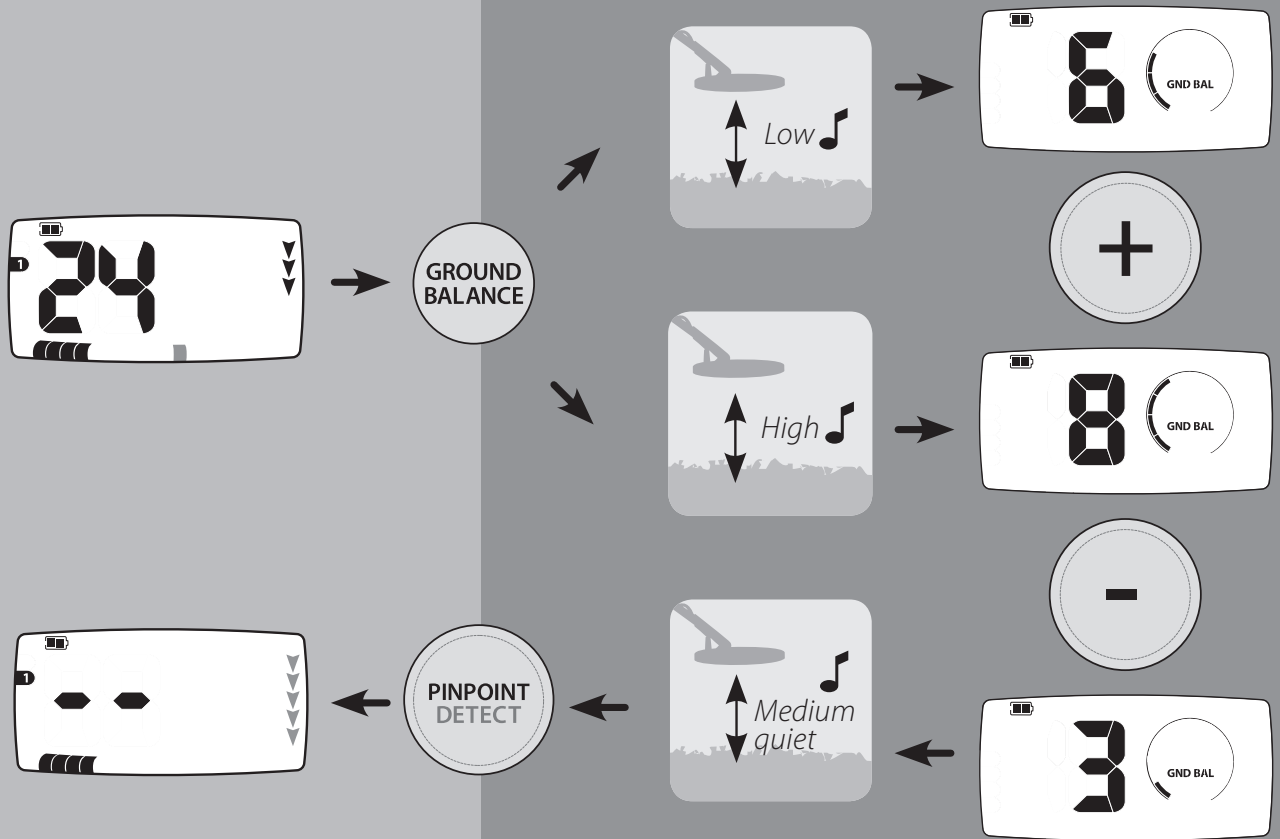

54 EDITING DISCRIMINATION PATTERNS - METHOD I

The detector's preset discrimination patterns can be edited to create custom patterns.

Method 1 - to reject a specific target ID using an actual target

In detection, a discrimination segment will flash, indicating its position on the discrimination scale and the target's ID number will appear on the LCD.

Press **ACCEPT REJECT** to reject that target ID.

The discrimination segment and **x** icon will appear and the target ID number will disappear to indicate the rejected ID.

Check that the target ID has been rejected by detecting again. There should be no audio response from that target ID.



Method 2 - to reject a specific target ID using + -

In detection, use + and - to scroll through and select the ID you want to modify. The flashing segment and the target ID numbers will indicate the selected ID.

Press **ACCEPT REJECT** to either accept or reject that ID. The discriminated segment and the **x** icon will appear (become shaded) if rejected. The segment and the **x** icon will disappear if accepted.



ACCEPT REJECT toggles between accepting and rejecting targets.



The all metal pattern cannot be edited.

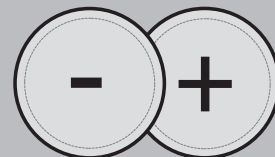

ERASING PATTERNS

Custom patterns are saved when the X-Terra is switched off. To erase custom patterns and return to preset patterns:

- 1 Turn the detector off.
- 2 While pressing and holding **PATTERNS**, turn the detector back on, by pressing power once.
- 3 During the start up sequence, release **PATTERNS**.
- 4 After the start up sequence, the patterns erased message (PE) will appear for 3 seconds to indicate that the current patterns have been erased and returned to the preset patterns.



PATTERNS

Press and hold



Press once

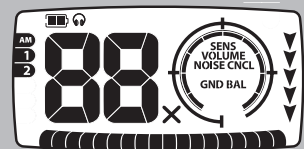

The settings sensitivity, volume, noise cancel* and ground balance are saved when the X-Terra is switched off. To return to the preset menu values:

- 1 Turn the detector off.
- 2 While pressing and holding **MENU SELECT**, turn the detector back on, by pressing **POWER** once.
- 3 During the start up sequence, release **MENU SELECT**.

After the start up sequence, the factory preset message (FP), will appear for 3 seconds to indicate that sensitivity, volume, noise cancel* and ground balance* have returned to the preset values.

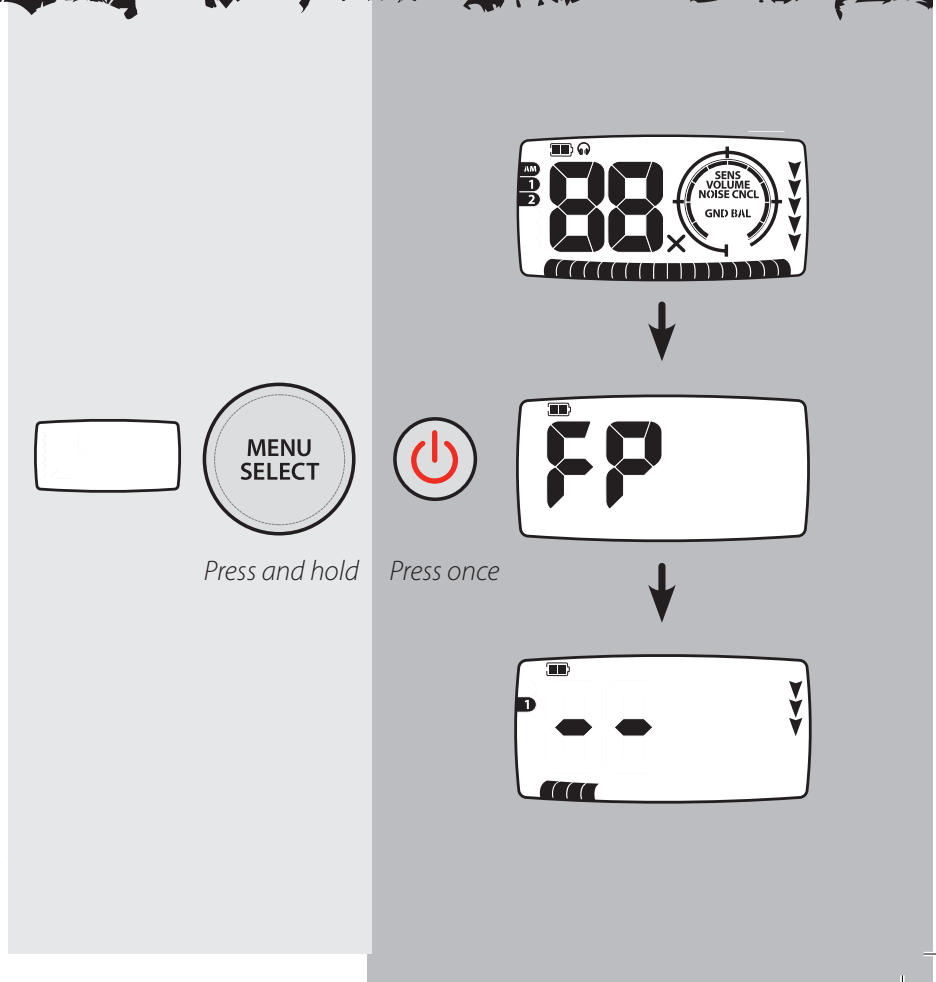

Start Up Sequence

When the detector is turned on, there is a short three note tune during its start up sequence.

Positive Acknowledgement

The detector emits a short beep for every accepted key press.

Negative Acknowledgement

The detector emits a low double beep to indicate an invalid keypress.

Completed

A three note tune indicates the completion of a function (e.g. noise cancel* channel calibration).

Patterns Erased / Factory Preset

A six note tune will announce when these settings are complete.

Error

A six note tune will sound to indicate a detector error (*Error Messages, pg. 60*).

Overload

If the coil is passed across a large shallow target, the detector will give a repeating buzzing sound. This indicates that the target signal is too strong for the detector to interpret.

Low Battery Signal

When the battery power becomes low, there will be a short announcement tune (descending tones) every 60 seconds.

Low Battery Shutdown

A long announcement tune (descending tones) will sound just before the detector shuts down.

Target Response

This is the sound given by the detector when a target is located and not discriminated against (rejected). Generally a target that is highly conductive (e.g. a large silver coin) emits a high tone beep. A low tone beep is produced for ferrous targets.

Pinpoint Response

When in pinpoint, the detector emits a variable tone, that increases in pitch and volume as the coil gets closer to the target.

Noise

A random jittery sound indicates that the detector is picking up external interference. Sensitivity or noise cancel* should be adjusted.

False Detections

A partial or chopped non-repeatable signal. Two dashes will indicate on the LCD to indicate a rejected target.

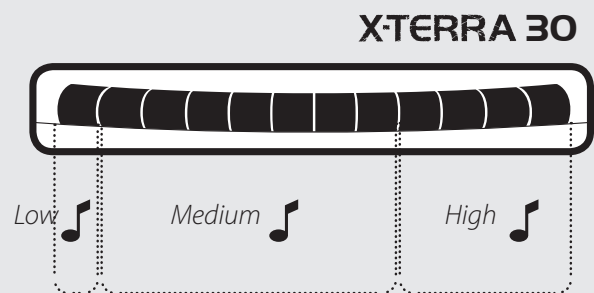

*The X-Terra 30 discrimination segments are separated by **3** different tones of sound*

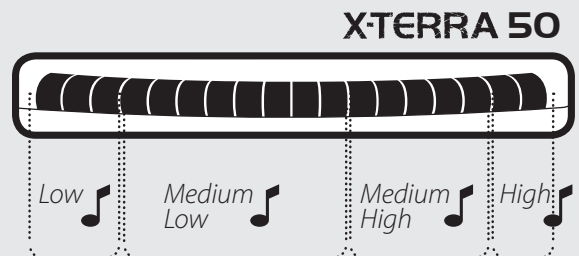

*The X-Terra 50 discrimination segments are separated by **4** different tones of sound*

Coil Unplugged

The coil has been disconnected from the detector.



The menu scale line icon will slowly flash until the coil is plugged back in.

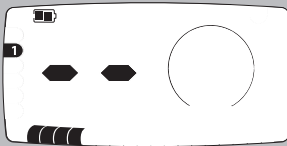

Turn the detector off. Send the coil and detector to be repaired.

**Coil Error**

The coil is not communicating with the control box.



The menu scale line icon will slowly flash until a standard coil is connected.

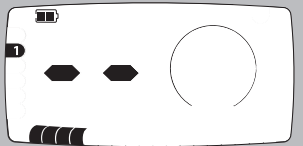

Turn the detector off before connecting a standard coil.



Coil Incompatible

The coil is communicating with the control box but the detector is not recognising it.



The menu scale line icon will slowly flash.



Turn the detector off before connecting a standard coil.



Overload

The detector has received a signal that is too strong for it to interpret. This will appear until there is no more overload (pg. 20).



Take the coil away from the source of overload.



Once all errors are resolved the detector will begin operation with a blank detection screen.

62 BATTERY BEHAVIOUR

The X-Terra is capable of using different types of AA batteries:

1.5 V Alkaline

1.5 V Carbon

1.5 V Lithium (non-rechargeable)

1.2 V NiMH (rechargeable)

1.2 V NiCad (rechargeable)

The adjacent graph is a representation of how both types of batteries may discharge over time. How the detector is used will affect how long the batteries last for.



Rechargeable Lithium Ion batteries will give a combined voltage above 8 V and therefore cannot be used with the X-Terra

When the detector battery is low, the speaker volume limit will be reduced, to save battery power and extend detecting time.

The headphone volume is not affected.



The use of headphones will increase battery life.

Overvoltage

If the battery voltage is too high, (above 8 V) the battery icon will flash and the detector will shut down.



Full

2 black segments inside the outline.



Half

1 black segment inside the outline.



Low

The icon will begin to flash for a period of time and there will be audio announcements every 60 seconds before the detector finally shuts down.



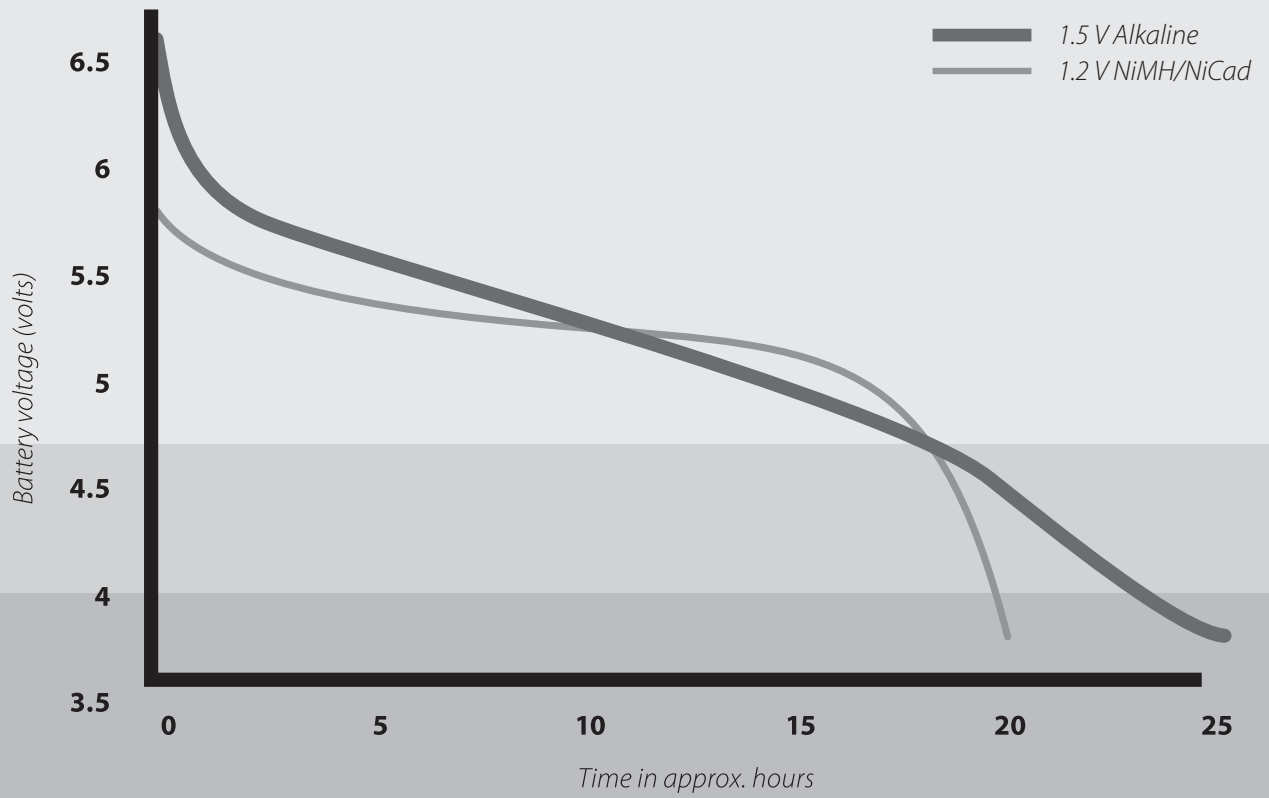

64 CARE OF YOUR X-TERRA

The X-Terra is a high quality electronic instrument, finely engineered and packaged in a durable housing. Taking proper care of your X-Terra is common sense.

! The X-Terra's storage temperature is -4°F to 149°F (-20°C to +65°C) and the operating temperature is 32°F to 113°F (0°C to 45°C). Do not leave the detector in excessive heat or cold for longer than necessary. Try to avoid leaving it in a closed trunk or in a car sitting in sunlight. Covering it when not in use will help protect it.

! The coil can be submersed in water up to 20" (0.5m), yet the control box is not waterproof. Although it has been designed to be weather resistant, it is advised to protect the control box in wet conditions. A protective control box cover is available. (*Protective Accessories, pg. 68*)

! Never allow the detector to come into contact with gasoline or other petroleum based liquids.

! Keep the detector clean and dry and avoid getting sand and grit into the shafts or fastenings (e.g. yoke, twistlocks). Do not use solvents to clean the detector. Use a damp cloth with mild soap detergent.

- ❗ The display window may be prone to scratching or damage if not treated with care. A protective control box cover is available. (*Protective Accessories, pg. 68*)
- ❗ Ensure the coil cable is in good condition and not subject to undue stress (particularly where it is connected to the coil).
- ❗ Always remember to turn off the detector before changing coils.
- ❗ Previous Minelab coils will not function with the X-Terra detector.
- ❗ Old, flat or faulty batteries may cause many detector problems, through electrolyte leakage. Take the batteries out if the detector will not be used for long periods of time (e.g. more than 1 week). Ensure that only good quality batteries are used and that they are replaced when the low battery signal
- ❗ Do not use rechargeable Lithium Ion batteries as their voltage is too high. Non rechargeable Lithium batteries may be used.

66 ACCESSORY HEADPHONES

Headphones have many advantages. They block out external noise such as wind and traffic, allowing you to listen more closely to target signals. Headphones also minimise disturbance to other people in the area and they extend battery life.

The X-Terra is able to save separate settings for both the speaker volume and headphone volume, switching from one to the other as soon as the headphones are connected.

(Volume, pg. 46)



Ensure that the headphone volume does not reach an extremely loud level. This may increase the risk of hearing damage.



Connecting Headphones

Always use headphones with a ¼" jack.

- 1 Open the rubber headphone cover located on the left hand side of the control box.
- 2 Plug the headphone jack into the socket.
- 3 When the detector is turned on, the headphones icon will appear on the LCD to indicate that the headphones are connected.



When not using headphones, keep the rubber cover closed to protect the control box electronics from moisture and dust.

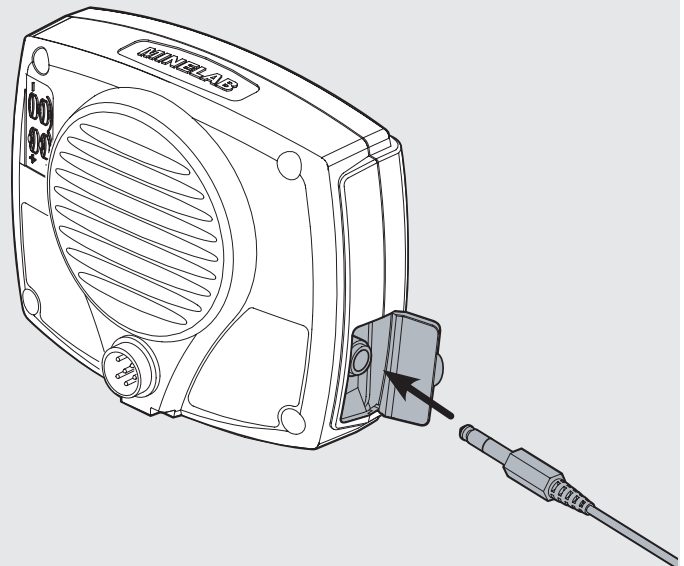

68 PROTECTIVE ACCESSORIES

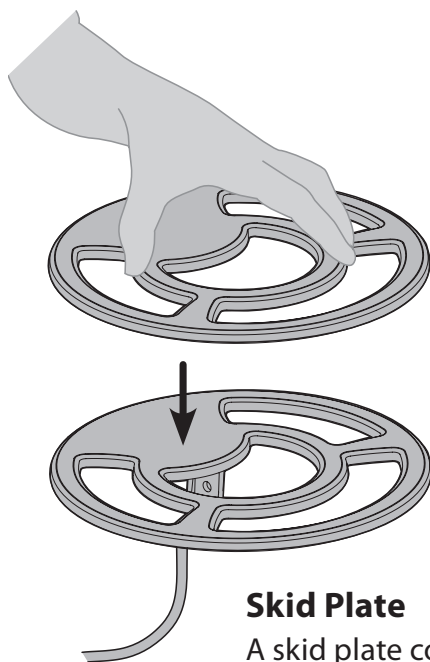

Skid Plate

A skid plate comes as standard with the detector. If it wears out from excessive sweeping along the ground, accessory skidplates are available for purchase.

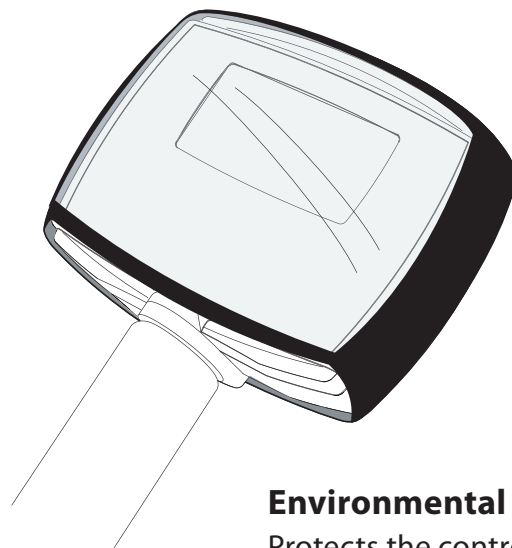



Environmental Cover

Protects the control box from environmental conditions such as rain and dirt.

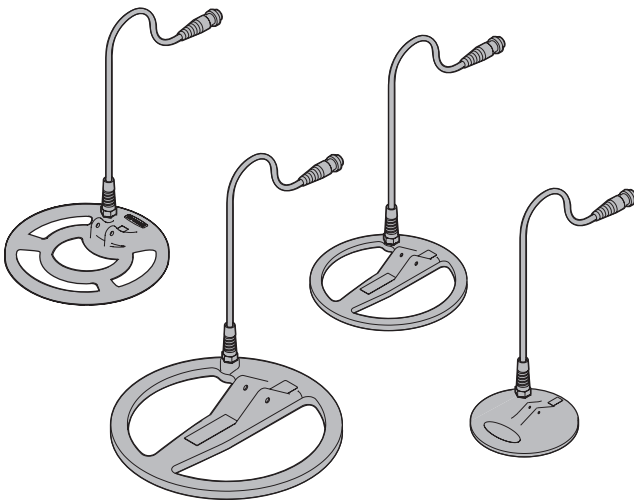
Accessory coils come in different types (Double D and Concentric), sizes and frequencies*. These coils are suitable for different ground conditions and specific targets.



To attach an accessory coil:

- 1 Turn the detector off using **POWER**. 
- 2 Follow the steps of *Coil Cable Assembly* (pg. 12) and *Connecting the Coil* (pg. 8) in reverse order to disconnect the coil from the detector.
- 3 Repeat the same steps in the correct order to connect a different coil.
- 4 Turn the detector on using **POWER** 

Transmission	<i>Single Frequency Sine Wave</i>
Technology	<i>VFLEX</i>
Coil	<i>9" Concentric 7.5 kHz</i>
Visual Display	<i>Positive Reflective LCD</i>
Audio	<i>Internal Speaker and Headphone Output</i>
Search Mode	<i>Motion Detector</i>
Discrimination	<i>Multi Segment Accept/Reject</i>
Batteries (Not Included)	<i>4 x AA Alkaline/Carbon/Lithium or NiMH/NiCad</i>
Padded Armrest	<i>4 Position Adjustable with Stand & Armrest</i>
Length Extended	<i>56" (1.42m)</i>
Length Unextended	<i>48" (1.22m)</i>
Weight (Excluding Batteries)	<i>2.9lbs (1.3kg)</i>
Optional Accessories	<i>Headphones, Skidplates, Environmental Cover, Coils</i>
Patents	<i>Pending</i>

***In the interest of product improvement,
Minelab reserves the right to make changes without notice.***

X-TERRA MODEL FEATURES 71

Model Features	X-Terra 30	X-Terra 50
Coil Frequency Options	1 (Standard 7.5 kHz)	2 (Standard 7.5 kHz, High 18.75 kHz)
Discrimination Patterns	1 + All Metal	2 + All Metal
All Metal Shortcut	✗	✓
Discrimination Scale (Segments)	12	18
Ferrous	1	3
Non-ferrous	11	15
Numeric Range (Target ID Numbers)	Steps of 4 (-4, 4, 8, 12, 16, 20, 24, 28, 32, 36, 40, 44)	Steps of 3 (-9, -6, -3, 3, 6, 9, 12, 15, 18, 21, 24, 27, 30, 33, 36, 39, 42, 45)
Depth	Standard	Enhanced
Depth Indication Icons	5	5
Sensitivity Adjustment	1-10	1-20
Noise Cancel Channels	✗	3 (-1, 0, 1)
Ground Balance Adjustment	Fixed	Manual (0-20)
Pinpoint (Audio & Visual)	✓	✓
Volume Adjustment	0-10	0-20
Audio Tones for Targets	3	4
Low Battery Audio Alarm	✓	✓
User Interface Keys	6 + Power	8 + Power
LCD Icons	64	70
Shaft Colour	Dulux Wineberry 51046	Dulux Navy 50282

72 USER PREFERENCES

X-TERRA 30

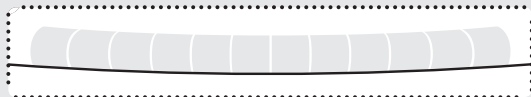
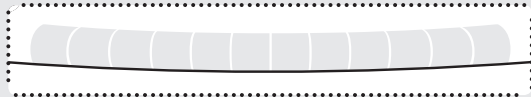
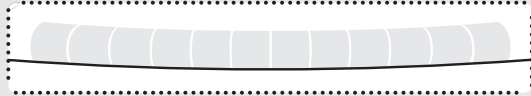

.....

.....

.....

.....

.....

X-TERRA 50

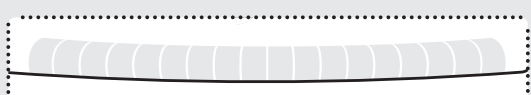
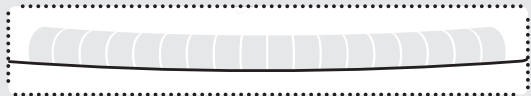

.....

.....

.....

.....

.....

QUICK START REFERENCE

- 1 Turn on (pg. 20) 
- 2 Choose a discrimination pattern (pg. 32, 33)
- 3 Adjust sensitivity (pg. 45) and volume (pg. 47)
- 4 Choose a noise cancel* channel (pg. 49)
- 5 Adjust ground balance* (pg. 52)
- 6 Begin detecting! (pg. 24)

These quick start instructions allow you to begin detecting straight away and find important reference information for setting up your X-Terra.

Minelab however encourages all users to read the entire manual to ensure a complete understanding of all features and functions your X-Terra offers.

** Available on X-Terra 50 model only.*



MINELAB

X-TERRA



VFLEX
technology

30 | 50



The World Leader in Metal Sensing Technology

From our origins in 1985, Minelab have specialised in advanced electronics technologies. Our competitive advantage was created almost immediately with a highly competent and innovative Research and Development team, inspired by the genius of Mr. Bruce Candy.

This commitment to innovation has enabled us to successfully market feature-packed Consumer coin and treasure detectors enjoyed by hobbyists worldwide as well as high quality gold detectors used by both professionals and amateurs. Minelab's advanced technology is also incorporated in detection equipment designed for military and humanitarian de-mining projects throughout the world.

Today Minelab has manufacturing, distribution and customer service operations in Australia, Europe and the United States, and is an ISO 9001 Quality Endorsed Company. ISO 9001 is a worldwide quality standard certification that ensures the highest level of product quality for our customers.

**For further product information
and detecting tips, refer to:**

WWW.MINELAB.COM



Minelab Electronics Pty Ltd

PO Box 537 Torrensville Plaza
South Australia 5031

AUSTRALIA

Tel: 618 8238 0888

Fax: 618 8238 0890

Email: minelab@minelab.com.au



Minelab International Ltd

Laragh, Bandon
Co. Cork

IRELAND

Tel: 353 23 52 101

Fax: 353 23 52 106

Email: minelab@minelab.ie



Minelab USA Inc

871 Grier Drive, Suite B1
Las Vegas, Nevada 89119

USA

Tel: 1 702 891 8809

Fax: 1 702 891 8810

Email: minelab@minelabusa.com

Please return the tear off section of your warranty card to Minelab as soon as possible.

Disclaimer: The Minelab metal detector discussed in this operating manual has been expressly designed and manufactured as a quality hobbyist metal detector and is recommended for use in coin, treasure and general metal detection in non-hazardous environments. This metal detector has not been designed for use as a mine detector or as a live munitions detection tool.

Working for a Cleaner, Greener Future



For Consumers within the European Union:
Do not dispose of this equipment in general household waste.

The crossed out wheeled bin indicated on this equipment is an indicator that this unit should not be disposed of in general household waste, but recycled in compliance with local government regulations or environmental requirements.

Please dispose of this equipment via a recycling service or centre, or by returning the unit to the respective Minelab or Halcro outlet as appropriate for your unit. This will enable the equipment to be disposed of in an environmentally safe manner.

Disposal of unwanted electronic equipment in landfilled waste may contribute to adverse long term environmental effect due to the leaching of contaminating and toxic substances contained within some electronic equipment.

THIS DEVICE COMPLIES WITH PART 15 OF THE FCC RULES

Operation is subject to the following two conditions: (1) this device may not cause harmful interference, and (2) this device must accept any interference received, including interference that may cause undesired operation.

Please note:

Since there may be a variety of options available for this detector, equipment may vary according to the model or items ordered with your detector. Certain descriptions and illustrations may also differ (in this manual) from the exact model that you purchased. In addition, Minelab reserves the right to respond to ongoing technical progress by introducing changes in design, equipment and technical features at any time.



Item Number: 4901 - 0055
Revision: 1.1

SERVICE REPAIR FORM

Today's Date

Detector Model

Serial Number

Purchased From

Purchase Date

Faulty Part(s)

Owners Name

Address

Phone () Day

Home

Fax ()

Email

